



**National
Construction
Code**

Handbook



Fire Safety Verification Method



abcb.gov.au

Copyright

© Commonwealth of Australia and States and Territories of Australia 2020, published by the Australian Building Codes Board.



The material in this publication is licensed under a Creative Commons Attribution-4.0 International licence, with the exception of

- Any third party material
- Any trade marks, and
- Any images or photographs.

More information on this CC BY licence is set out at the Creative Commons website (creativecommons.org/licenses/by/4.0).

Enquiries about this publication can be sent to:

Australian Building Codes Board
GPO Box 2013
CANBERRA ACT 2601
Phone: 1300 134 631
Email: ncc@abcb.gov.au
Web: abcb.gov.au

Attribution

Use of all or part of this publication must include the following attribution:

© Commonwealth of Australia and States and Territories 2020, published by the Australian Building Codes Board.

Disclaimer

By accessing or using this publication, you agree to the following:

While care has been taken in the preparation of this publication, it may not be complete or up-to-date. You can ensure that you are using a complete and up-to-date version by checking the Australian Building Codes Board website (abcb.gov.au).

The Australian Building Codes Board, the Commonwealth of Australia and States and Territories of Australia do not accept any liability, including liability for negligence, for any loss (howsoever caused), damage, injury, expense or cost incurred by any person as a result of accessing, using or relying upon this publication, to the maximum extent permitted by law. No representation or warranty is made or given as to the currency, accuracy, reliability, merchantability, fitness for any purpose or completeness of this publication or any information which may appear on any linked websites, or in other linked information sources, and all such representations and warranties are excluded to the extent permitted by law.

This publication is not legal or professional advice. Persons rely upon this publication entirely at their own risk and must take responsibility for assessing the relevance and accuracy of the information in relation to their particular circumstances.

Version history

Original

Publish date: August 2019
Print version: 1.0

This version

Publish date: Apr 2020
Print version: 1.1
Details of amendments:
Removal of preview status

Preface

The Inter-Government Agreement (IGA) that governs the Australian Building Codes Board (ABCB) places a strong emphasis on reducing reliance on regulation, including consideration of non-regulatory alternatives such as non-mandatory handbooks and protocols.

This Handbook is one of a series produced by the ABCB developed in response to comments and concerns expressed by government, industry and the community that relate to the built environment. The topics of Handbooks expand on areas of existing regulation or relate to topics which have, for a variety of reasons, been deemed inappropriate for regulation. They provide non-mandatory advice and guidance.

The Fire Safety Verification Method (FSVM) Handbook assists in understanding the FSVM introduced into the National Construction Code (NCC) in the 2019 edition. It is expected that this Handbook will be used to guide solutions relevant to specific situations in accordance with the generic principles and criteria contained herein.

The FSVM must only to be used by a *professional engineer* or other *appropriately qualified person* recognised by the *appropriate authority* as having qualifications and/or experience in the discipline of fire safety engineering. Users should amongst other things be;

- proficient in the use of fire engineering modelling methods; and
- familiar with fire testing and
- validation of computational data.

Some critical inputs and other information have been provided in referenced appendices to facilitate the use of the FSVM in a consistent manner. These appendices are published separately on the ABCB website (abcb.gov.au) to facilitate regular updates and additions without requiring an update to this Handbook and/or the NCC. This facilitates the evolution of the FSVM in

response to emerging issues and maximises opportunities for the wider adoption of innovative approaches.

The NCC is a performance-based code containing *Performance Requirements* for the construction of buildings. A building, plumbing or drainage solution will comply with the NCC if it satisfies the *Performance Requirements*, which are the mandatory requirements of the NCC.

The FSVM is not mandatory and is just one of many means of demonstrating compliance and may not be suitable as a means of demonstration of compliance in some situations.

The key to the performance-based NCC is that there is no obligation to adopt any particular material, component, design factor, or construction method and a choice of *assessment methods* is available (of which the FSVM is one). This provides for a choice of compliance pathways. The *Performance Requirements* can be met using either a *Performance Solution* or using a *Deemed-to-Satisfy (DTS) Solution* or a combination of both. For more information please visit the ABCB website (abcb.gov.au).

Other *Performance Requirements* not covered by the FSVM may need to be considered in order to comply with NCC Volume One A.2.2(3) and A2.4(3). It is necessary to understand the interrelationships between other requirements and the requirements relevant within the FSVM to ensure no design conflicts arise.

Contents

1	Background	1
1.1	Scope	1
1.2	Design and approval of Performance Solutions	2
1.3	Using this document.....	3
2	Introduction	4
3	Organisation and interpretation	9
3.1	Relationship to the FSVM and NCC	9
3.2	Organisation of Handbook.....	9
3.3	FSVM Process	10
4	Building Regulation in Australia and the NCC	12
4.1	Overview of NCC 2019.....	12
4.2	The NCC compliance structure	12
4.3	<i>Performance Requirements</i> and benchmarking against the DTS requirements.....	13
4.4	Assessment Methods	15
5	Development of a fire safety strategy	20
5.1	Design process.....	20
5.2	Client and end user objectives	22
5.3	Individual and societal risk.....	22
5.4	Building life cycle	23
5.5	Other applicable Acts, Regulations and design responsibilities.....	24
5.6	Strategy development for NCC compliance.....	27
5.6.1	Objectives and <i>Performance Requirements</i>	27
5.6.2	Strategy for life safety.....	28
5.6.3	Strategy for protection of other property	28

5.6.4	Firefighter strategy.....	29
5.7	Fire safety strategy documentation.....	30
6	Performance-based design brief (PBDB) preliminaries	32
6.1	Overview of the PBDB.....	32
6.2	Objectives and scope	34
6.3	Stakeholders and their role in the PBDB process.....	35
6.3.1	Selection and general role of PBDB stakeholders	35
6.3.2	Peer review process	41
6.3.3	Coordinating the PBDB process.....	42
6.4	Description of the proposed fire safety strategy	42
6.5	Selection of Assessment Methods for determining the <i>Performance Requirements</i> have been satisfied	43
6.6	Derivation of reference building.....	44
7	Identification of departures from NCC <i>DTS Provisions</i> and related <i>Performance Requirements</i> that may be affected	50
8	Process for identification and development of scenarios	54
8.1	Identification scenarios required by FSVM for consideration.....	54
8.2	Deriving reference <i>design scenarios</i>	58
8.3	Deriving design fires.....	60
8.4	Deriving occupant characteristics / scenarios.....	62
9	Derivation of reference scenarios from FSVM prescribed scenarios	65
9.1	Design scenario (BE): Blocked exit	66
9.1.1	Intent	66
9.1.2	Background	66
9.1.3	Derivation of reference scenarios and performance criteria	66
9.1.4	Typical mitigation measures	72

9.2	Design scenario (UT): Normally unoccupied room	72
9.2.1	Intent	72
9.2.2	Background	72
9.2.3	Derivation of reference scenarios and performance criteria	73
9.2.4	Typical mitigation measures	74
9.3	Design scenario (CS): Concealed space	75
9.3.1	Intent	75
9.3.2	Background	75
9.3.3	Derivation of reference scenarios and performance criteria	76
9.3.4	Typical mitigation measures	77
9.4	Design scenario (SF): Smouldering fire	77
9.4.1	Intent	77
9.4.2	Background	77
9.4.3	Derivation of reference scenarios and performance criteria	78
9.4.4	Typical mitigation measures	78
9.5	Design scenario (HS): Horizontal fire spread	79
9.5.1	Intent	79
9.5.2	Background	79
9.5.3	Derivation of reference scenarios and performance criteria	79
9.5.4	Typical mitigation measures	80
9.6	Design scenario (VS): Vertical fire spread	80
9.6.1	Intent	80
9.6.2	Background	80
9.6.3	Derivation of reference scenarios and performance criteria	81
9.6.4	Typical mitigation measures	81
9.7	Design scenario (IS): Internal surfaces	81
9.7.1	Intent	81
9.7.2	Background	82
9.7.3	Derivation of reference scenarios and performance criteria	83

9.7.4	Typical mitigation measures	85
9.8	Design scenario (FI): Fire brigade intervention.....	86
9.8.1	Intent	86
9.8.2	Background	86
9.8.3	Derivation of reference scenarios and performance criteria	87
9.8.4	Typical mitigation measures	89
9.9	Design scenario (UF): Unexpected catastrophic failure.....	90
9.9.1	Intent	90
9.9.2	Background	90
9.9.3	Derivation of reference scenarios and performance criteria	94
9.9.4	Typical mitigation measures	95
9.10	Design scenario (CF): Challenging fire.....	95
9.10.1	Intent	95
9.10.2	Background	96
9.10.3	Derivation of reference scenarios and performance criteria	97
9.10.4	Typical mitigation measures	98
9.11	Design scenario (RC): Robustness check.....	98
9.11.1	Intent	98
9.11.2	Background	99
9.11.3	Derivation of reference scenarios and performance criteria	101
9.11.4	Typical mitigation measures	102
9.12	Design scenario (SS): Structural stability	102
9.12.1	Intent	102
9.12.2	Background	102
9.12.3	Derivation of reference scenarios and performance criteria	105
9.12.4	Typical mitigation measures	105
9.13	Additional scenarios	105
10	Analysis methods, inputs and criteria for comparison.....	107

10.1	General principles.....	107
10.2	Verification and validation of methods of analysis	108
10.3	Fire models.....	108
10.4	Evacuation and human behaviour models.....	109
10.5	Human exposure models.....	110
10.5.1	Occupant tenability criteria	110
10.5.2	Firefighter tenability criteria	111
10.6	Heat transfer models	113
10.7	Structural models.....	113
10.8	Application of data from test methods surveys and technical literature 114	
10.9	Application of data from reference tests	114
10.10	Criteria for evaluation of scenarios	115
11	Performance-based design brief (PBDB) report.....	116
12	Performance-based design risk assessment.....	118
12.1	Overview of performance-based design risk assessment	118
12.2	Frequency analysis.....	120
12.3	Consequence analysis	122
12.4	Comparison with the reference building	124
13	Performance-based design report (PBDR).....	125
14	References	127
	Appendices	131
	Appendix A Compliance with the NCC	132
A.1	Responsibilities for regulation of building and plumbing in Australia ..	132
A.2	Demonstrating compliance with the NCC	132
	Appendix B Acronyms and symbols	135

Appendix C	Defined terms	138
Appendix D	History of the NCC	145
D.1	Australian building regulatory system	145
D.2	Australia's Model Uniform Building Code	145
D.3	Building Code of Australia	146
D.4	Transition to the NCC	147

REMINDER

This Handbook is not mandatory or regulatory in nature and compliance with it will not necessarily discharge a user's legal obligations. The Handbook should only be read and used subject to, and in conjunction with, the general disclaimer at page i.

The Handbook also needs to be read in conjunction with the relevant legislation of the appropriate State or Territory. It is written in generic terms and it is not intended that the content of the Handbook counteract or conflict with the legislative requirements, any references in legal documents, any handbooks issued by the Administration or any directives by the Appropriate Authority.

1 Background

The National Construction Code (NCC) is a performance-based code containing all *Performance Requirements* for the construction of buildings. To comply with the NCC, a solution must achieve compliance with the Governing Requirements and the *Performance Requirements*. The Governing Requirements contain requirements about how the *Performance Requirements* must be met. A building, plumbing or drainage solution will comply with the NCC if it satisfies the *Performance Requirements*, which are the mandatory requirements of the NCC.

This document was developed to provide guidance to practitioners seeking to demonstrate compliance with the fire safety *Performance Requirements* of NCC Volume One using the *Fire Safety Verification Method* (FSVM).

1.1 Scope

The Handbook is structured to first provide the reader with a basic understanding of the FSVM. It then goes on to provide detailed information on the FSVM.

The Handbook also needs to be read in conjunction with the relevant legislation of the appropriate State or Territory. It is written in generic terms and it is not intended that the content of the Handbook counteract or conflict with the legislative requirements, any references in legal documents, any handbooks issued by the Administration or any directives by the *Appropriate Authority*.

This Handbook has been developed to assist competent practitioners verify compliance with the NCC using the FSVM included in Schedule 7 of the NCC 2019^[1]. Background information relating to the FSVM and some other matters that need to be considered when deriving a fire safety design (strategy) for a building is provided to help practitioners:

- determine if the FSVM is the most appropriate *assessment method* for a *Performance Solution* relating to fire safety on a particular building; and
- highlight that there are other criteria that need to be considered when developing a fire safety design / strategy.

The handbook provides general guidance on the processes to be followed when using the FSVM with more detailed technical guidance being provided in appendices and other referenced documents. This approach may also inform stakeholders that may participate in the development of a performance-based design brief (PBDB) at least in respect of the process followed which is based on internationally recognised principles of stakeholder engagement and agreement about performance benchmarks.

The document has been written to complement the FSVM and NCC 2019. Its application to other editions of the NCC needs to be confirmed by the document user.

This Handbook is not a comprehensive guide to fire safety. Reference should be made to appropriate technical documentation such as the International Fire Engineering Guidelines (IFEG)^[5] or ISO 23932-1:2018 Fire safety engineering – General Principles^[6] and related standards for more detailed information.

Further reading on this topic can be found with the references.

1.2 Design and approval of Performance Solutions

The design and approval processes for fire safety solutions is expected to be similar to that adopted for demonstrating compliance through other NCC Performance Solutions including registration of practitioners. Since the design approval process for Performance Solutions varies between the responsible State and Territory governments it is likely to also be the case with FSVM and requirements should be checked for the relevant jurisdiction.

Notwithstanding the quantified input and acceptance criteria, other qualitative aspects of the FSVM, which are discussed in this document, require assessment and analysis throughout the design and approval process. The advice of an appropriately qualified person should be sought to undertake this assessment and analysis where required, and may be aided by the early and significant involvement from regulatory authorities, peer reviewer(s) and / or a technical panel as appropriate to the State or Territory jurisdictions.

1.3 Using this document

General information about complying with the NCC and responsibilities for building and plumbing regulation are provided in Appendix A of this document.

Acronyms and symbols used in this document are provided in Appendix B.

Italicised terms are defined terms used in this document. They may align with a defined term in the NCC or be defined for the purpose of this document. See Appendix C for further information. References, a bibliography and further reading are also provided.

Different styles are used in this document. Examples of these styles are provided below:

NCC extracts

Examples

Alerts

Reminders

2 Introduction

The Handbook needs to be read in conjunction with the relevant legislation of the appropriate State or Territory. It is written in generic terms and it is not intended that the content of the Handbook counteract or conflict with the legislative requirements, any references in legal documents, any handbooks issued by the Administration or any directives by the *Appropriate Authority*.

This Handbook has been developed to assist practitioners verify compliance with the NCC using the FSVM included in Schedule 7 of Volume One of the NCC 2019^[1].

The FSVM defines a verification process for fire safety *Performance Solutions*. To ensure that the level of safety required by the NCC is achieved and that the impact of the introduction of the verification method would be policy neutral, the FSVM was based on combination of the following existing NCC Governing Requirements to define a compliance pathway;

NCC Volume One A2.2 Performance Solution

- (1) A *Performance Solution* is achieved by demonstrating—
 - (a) compliance with all relevant *Performance Requirements*; or
 - (b) the solution is at least equivalent to the Deemed-to-Satisfy Provisions.
- (2) A *Performance Solution* must be shown to comply with the relevant *Performance Requirements* through one or a combination of the following *Assessment Methods*:
 - (a) Evidence of suitability in accordance with Part A5 that shows the use of a material, product, *plumbing* and *drainage product*, form of construction or design meets the relevant *Performance Requirements*.
 - (b) A *Verification Method* including the following:
 - (i) The *Verification Methods* provided in the NCC.
 - (ii) Other *Verification Methods*, accepted by the *appropriate authority* that show compliance with the relevant *Performance Requirements*.
 - (c) Expert Judgement.
 - (d) Comparison with the Deemed-to-Satisfy Provisions.

- (3) Where a *Performance Requirement* is satisfied entirely by a *Performance Solution*, in order to comply with (1) the following method must be used to determine the *Performance Requirement* or *Performance Requirements* relevant to the *Performance Solution*:
- (a) Identify the relevant *Performance Requirements* from the Section or Part to which the *Performance Solution* applies.
 - (b) Identify *Performance Requirements* from other Sections or Parts that are relevant to any aspects of the *Performance Solution* proposed or that are affected by the application of the *Performance Solution*.

NCC Volume One A2.4 A combination of solutions

- (1) Performance Requirements may be satisfied by using a combination of Performance Solutions and Deemed-to-Satisfy Solutions.
- (2) When using a combination of solutions, compliance can be shown through the following, as appropriate:
 - (a) A2.2 for assessment against the relevant *Performance Requirements*.
 - (b) A2.3 for assessment against the relevant *Deemed-to-Satisfy Provisions*.
- (3) Where a *Performance Requirement* is satisfied by a *Performance Solution* in combination with a *Deemed-to-Satisfy Solution*, in order to comply with (1), the following method must be used to determine the *Performance Requirement* or *Performance Requirements* relevant to the *Performance Solution*:
 - (a) Identify the relevant *Deemed-to-Satisfy Provisions* of each Section or Part that are to be the subject of the *Performance Solution*.
 - (b) Identify the *Performance Requirements* from the same Sections or Parts that are relevant to the identified *Deemed-to-Satisfy Provisions*.
 - (c) Identify *Performance Requirements* from other Sections or Parts that are relevant to any aspects of the *Performance Solution* proposed or that are affected by the application of the *Deemed-to-Satisfy Provisions* that are the subject of the *Performance Solution*.

NCC Volume One A5.2 Evidence of suitability – Volumes One and Two

- (1) Subject to A5.4, A5.5 and A5.6, evidence to support that the use of a material, product, form of construction or design meets a *Performance Requirement*, or a *Deemed-to-Satisfy Provision* may be in the form of any one, or any combination of the following: ...
- (e) A certificate or report from a *professional engineer* or other *appropriately qualified person* that—
- (i) certifies that a material, product, form of construction or design fulfils specific requirements of the BCA; and
 - (ii) sets out the basis on which it is given and the extent to which relevant standards, specifications, rules, codes of practice or other publications have been relied upon to demonstrate its fulfils specific requirements of the BCA. ...

The equivalence to the *Deemed-to-Satisfy Provisions* provides a quantifiable benchmark against which compliance of a *Performance Solution* can be verified which is consistent with current NCC fire safety levels.

The FSVM must only be used by a *professional engineer* or other *appropriately qualified person* recognised by the *appropriate authority* as having qualifications and/or experience in the discipline of fire safety engineering. Users should amongst other things be;

- proficient in the use of fire engineering modelling methods; and
- familiar with fire testing and validation of computational data.

This is consistent with NCC Clause A5.2(1)(e) which requires a report from a *professional engineer* or other *appropriately qualified person*.

Reminder

Some jurisdictions have introduced regulations with specific requirements for the registration of fire safety engineers (FSE) which apply in that jurisdiction. There is also a National Engineers Register (NER) with Special Area of Practice – Fire Safety

Engineering administered by Engineers Australia and the National Fire Engineers Register (NFER) administered by the Institution of Fire Engineers Australia (in the area of practice of fire engineering) which is recognised within some jurisdictions as evidence that a professional engineer is suitably qualified and experienced with the relevant competency in the field of fire safety engineering.

These requirements are provided to ensure that the verification method is used by appropriately qualified practitioners.

The FSVM specifies a minimum of twelve *design scenarios* for consideration in order to determine if a building incorporating *Performance Solutions* satisfies the relevant *Performance Requirements*. Each *design scenario* is considered in one or more locations to compare the proposed solution against a reference building complying fully with the NCC DTS requirements. The scenarios are summarised in Table 2.1.

Table 2.1 Overview of fire scenarios

Ref	Design scenario	Design scenario description
BE	Fire blocks <i>evacuation route</i>	A fire blocks an <i>evacuation route</i>
UT	Fire in a normally unoccupied room threatens occupants of other rooms	A fire starts in a normally unoccupied room and can potentially endanger a large number of occupants in another room
CS	Fire starts in concealed space	A fire starts in a concealed space that can facilitate fire spread and potentially endanger a large number of people in a room
SF	Smouldering fire	A fire is smouldering in close proximity to a sleeping area
HS	Horizontal fire spread	A <i>fully developed fire</i> in a building exposes the <i>external walls</i> of a neighbouring building (or potential building) and vice versa
VS	Vertical fire spread involving cladding or arrangement of openings in walls	A fire source exposes a wall and leads to significant vertical fire spread
IS	Fire spread involving internal finishes	Interior surfaces are exposed to a growing fire that potentially endangers occupants

Ref	Design scenario	Design scenario description
FI	Fire brigade intervention	Facilitate fire brigade intervention to the degree necessary
UF	Unexpected catastrophic failure	A building must not unexpectedly collapse during a fire event
CF	Challenging fire	Worst credible fire in an occupied space
RC	Robustness check	The requirements of the NCC should be satisfied if failure of a critical part of the fire safety systems
SS	Structural stability and other properties	Building does not present risk to other properties in a fire event. Consider risk of structural failure

This approach of prescribing *design scenarios* has been included in the FSVM to reduce the risk of critical *design scenarios* not being identified when determining compliance of a *Performance Solution* with the *Performance Requirements*. Similar approaches have been adopted in New Zealand through C/VM2^[2] and the US through NFPA5000^[3]. For further information on C/VM2 please refer to the New Zealand Ministry of Business, Innovation and Employment website (mbie.govt.nz).

ISO 16733-1 2015^[4] also describes the approach of identifying a list of prescribed scenarios relevant to the particular built environment that may be listed in a national code or standard with the regulator requiring that they be considered as a minimum as one of several approaches to identify design fire scenarios.

The FSVM in conjunction with this Handbook and associated data sheets is intended to facilitate improvements in the standards of analysis undertaken and improve consistency, increasing confidence in the fire safety engineering process and as a consequence increasing the use of performance-based approaches.

The data sheets are provided on the ABCB website (abcb.gov.au) separately to allow for ongoing development / amendment in response to feedback from users.

3 Organisation and interpretation

3.1 Relationship to the FSVM and NCC

This Handbook complements the FSVM within Volume One of the NCC and each is to be used in conjunction with the other. Using the FSVM without the Handbook may not result in a design which meets the fire safety *Performance Requirements* of the NCC.

The FSVM sets out specific *design scenarios* that must be considered to demonstrate that the fire safety aspects of a *Performance Solution* comply with the relevant fire safety *Performance Requirements* provided in NCC Volume One and also requires that the fire safety aspects of the *Performance Solution* be at least equivalent to the *Deemed-to-Satisfy Provisions*.

3.2 Organisation of Handbook

Chapter 1 provides background information relevant to the FSVM and Handbook.

Chapter 2 provides introductory information relevant to the FSVM and Handbook.

Chapter 3, this chapter:

- describes the structure of this Handbook, and
- provides an overview of the process to be followed when using the FSVM.

Chapter 4 describes the Australian building regulatory system relevant to the development of *Performance Solutions* to provide a context for the FSVM.

Chapter 5 provides general background on the development of a fire safety strategy for a building showing how the FSVM is a critical part of the process but also the importance of considering broader objectives to ensure an effective, comprehensive and reliable strategy is developed.

Chapters 6 through 11 describe the performance-based design brief (PBDB) process and Chapters 12 and 13 describe the performance-based design risk Assessment

process as they relate to the FSVM including matters such as the derivation of a reference building and derivation of reference scenarios from the *design scenarios*. These processes are critical to the successful application of the FSVM. Figure 3.1 provides a flow chart of the FSVM process with relevant chapters identified to assist the reader to navigate this document.

Some critical inputs and other information have been provided in referenced appendices to facilitate the use of the FSVM in a consistent manner. These appendices are published separately ABCB website (abcb.gov.au) to enable regular updates and additions without requiring an update to this Handbook and / or the NCC. This facilitates the evolution of the FSVM in response to emerging issues and maximises opportunities for the adoption of innovative approaches.

3.3 FSVM Process

Figure 3.1 shows the process to be followed when using the FSVM and this Handbook.

The FSVM requires consideration of prescribed *design scenarios* and guidance is provided in this Handbook relating to the following matters to facilitate the development and verification of *Performance Solutions* that are consistent with the fire safety levels expected by the NCC:

- derivation of fire safety strategies;
- the FSVM process including consultation with stakeholders and documentation;
- selection of appropriate reference buildings (DTS compliant buildings);
- selection of appropriate methods of analysis and input data; and
- comparison of risks posed by the *Performance Solutions* (in terms of both frequency and consequence).

Figure 3.1 FSVM process flow chart

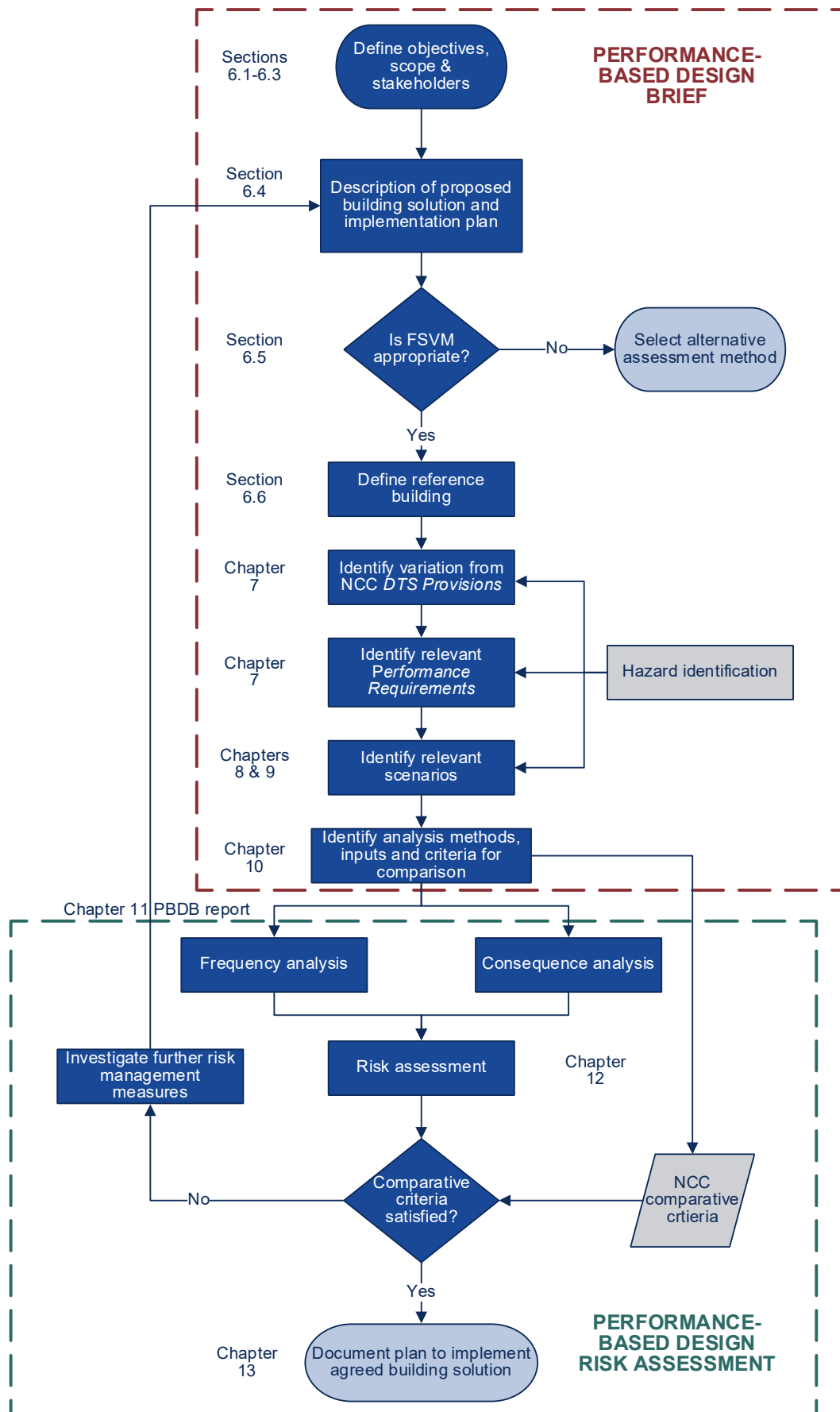

4 Building Regulation in Australia and the NCC

4.1 Overview of NCC 2019

This Handbook and the FSVM document are one means of demonstrating a *Performance Solution* complies with the fire safety *Performance Requirements* of NCC Volume One and buildings within its scope.

The NCC is drafted in a performance-based format allowing flexibility to develop a *Performance Solution* based on existing or new innovative building systems and designs, or the use of the prescriptive *DTS Provisions* to develop a *DTS Solution* generally with a simpler assessment process. A combination of a *Performance Solution* and a *DTS Solution* can also be adopted. A significant advantage of the performance-based NCC is that there is no obligation to adopt any particular material, component, design factor or construction method provided the *Performance Requirements* are satisfied.

The NCC is given legal effect by the relevant legislation in each State and Territory. This legislation prescribes or “calls up” the NCC to fulfil the main technical requirements which have to be satisfied when undertaking building work including fire safety measures.

The NCC should be read in conjunction with the legislation under which it is enacted. Any queries on such matters should be referred to the State or Territory authority responsible for building matters.

4.2 The NCC compliance structure

The NCC is a performance-based code built around a hierarchy of guidance and code compliance levels, with the *Performance Requirements* being the minimum level that buildings, building elements, and plumbing and drainage systems must meet and compliance with the *Performance Requirements* is mandatory.

Figure 4.1 depicts the compliance structure showing that the *Performance Requirements* can be met using a *Performance Solution*, a *Deemed-to-Satisfy* (DTS) Solution or a combination of both.

Figure 4.1 NCC compliance structure

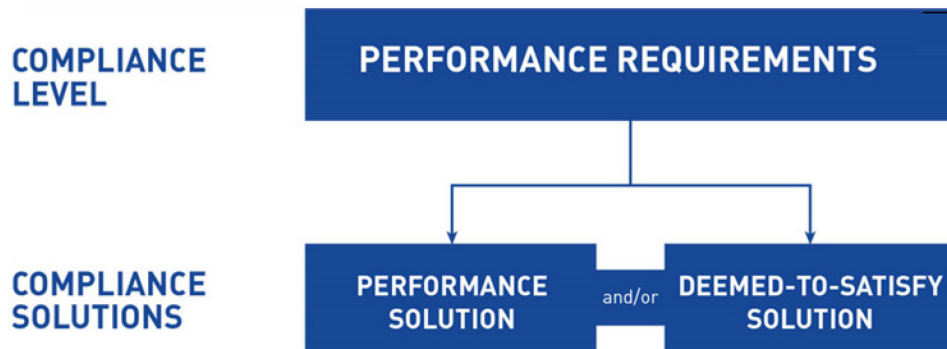

The *Performance Requirements* are also supported by Governing Requirements, which cover other aspects of applying the NCC including its interpretation, reference documents, the acceptance of design and construction (including related evidence of suitability / documentation) and the classification of buildings within the NCC.

A *Performance Solution* is unique for each individual situation. These solutions are often flexible in achieving the outcomes and encouraging innovative design and technology use. A *Performance Solution* directly addresses the *Performance Requirements* by using one or more of the Assessment Methods available in the NCC.

A DTS Solution follows a set recipe of what, when and how to do something. It uses the DTS Solutions from the NCC, which include materials, components, design factors, and construction methods that, if used, are deemed to meet the *Performance Requirements*.

4.3 *Performance Requirements* and benchmarking against the DTS requirements

The *Performance Requirements* specify the minimum level of performance which must be met for all relevant building materials, components, design factors, and

construction methods. They are the only parts of the code with which compliance is mandatory and are expressed as a mix of quantitative and qualitative terms depending, amongst other things, on the availability of appropriate quantification and associated *Verification Methods*. Most of the fire safety related *Performance Requirements* are currently expressed in qualitative terms. To assist in interpreting the *Performance Requirements* of NCC Volume One, the ABCB also publishes a non-mandatory Guide to Volume One^[7] which includes the relevant NCC Objectives and Functional Statements but these are also expressed in qualitative terms.

Unquantified (qualitative) *Performance Requirements* have been recognised as a limitation within performance-based codes and a barrier to the increased use of *Performance Solutions*. The ABCB has been tasked with quantifying all of the NCC's *Performance Requirements* and/or developing quantified *Verification Methods* to improve productivity and building outcomes. There are a number of qualitative *Performance Requirements* concerning fire safety and therefore the ABCB has developed the FSVM.

The initial BCA 1988 stated that its “basic objective is to ensure that acceptable standards of structural sufficiency, fire safety, health and amenity, are maintained for the benefit of the community now and in the future. The requirements included in this Code are intended to extend no further than is necessary in the public interest, to be cost effective, not needlessly onerous in their application, and easily understood”.

Over the 30-year period since the publication of the first BCA in 1988, the *DTS Provisions* have been continuously improved with most of the technical changes undergoing extensive consultation through the Australian Uniform Building Regulations Coordinating Council (AUBRCC), the ABCB, Standards Australia or other standards writing body public comment or equivalent processes, often supported by detailed fire safety analyses and cost benefit analyses where appropriate reflecting best practice regulation. A typical example from the early 1990s was described by Beck^[8].

The development of the *Performance Requirements* in the original performance-based version of the BCA^[9] were developed with the intention of being consistent with the existing DTS content.

Further details of the history behind the development of the BCA and NCC are provided in Appendix D.

A reasonable basis, in the absence of quantification of the NCC fire safety *Performance Requirements*, in most instances is to presume that the quantified acceptance criteria that reflect community expectations can be derived by comparison with the current NCC *DTS Provisions*. This benchmark was therefore adopted for the FSVM, noting the need to consider the validity of this approach in each instance.

4.4 Assessment Methods

The NCC identifies four broad categories of assessment methods that can be used individually or in combination to determine compliance with the *Performance Requirements* as appropriate in Clause A2.2(2) which is reproduced below:

NCC Volume One A2.2 Performance Solution

- (1) A *Performance Solution* is achieved by demonstrating—
 - (a) compliance with all relevant *Performance Requirements*; or
 - (b) the solution is at least *equivalent* to the *Deemed-to-Satisfy Provisions*.
- (2) A *Performance Solution* must be shown to comply with the relevant *Performance Requirements* through one or a combination of the following *Assessment Methods*:
 - (a) Evidence of suitability in accordance with Part A5 that shows the use of a material, product, *plumbing* and *drainage product*, form of construction or design meets the relevant *Performance Requirements*.
 - (b) A *Verification Method* including the following:
 - (i) The *Verification Methods* provided in the NCC.
 - (ii) Other *Verification Methods*, accepted by the appropriate authority that show compliance with the relevant *Performance Requirements*.
 - (c) *Expert Judgement*.
 - (d) Comparison with the *Deemed-to-Satisfy Provisions*.
- (3) Where a *Performance Requirement* is satisfied entirely by a *Performance Solution*, in order to comply with (1) the following method must be used to

determine the *Performance Requirement* or *Performance Requirements* relevant to the *Performance Solution*:

- (a) Identify the relevant *Performance Requirements* from the Section or Part to which the *Performance Solution* applies.
- (b) Identify *Performance Requirements* from other Sections or Parts that are relevant to any aspects of the *Performance Solution* proposed or that are affected by the application of the *Performance Solution*.

Comparison with the *DTS Provisions* has been an acceptable assessment method for *Performance Solutions* (known as *Alternative Solutions* in early editions of the BCA) since the release of the first performance BCA in 1996, therefore, the FSVM is consistent with permitted assessment methods in earlier editions of the NCC and BCA.

Clause A5.2 of the NCC provides a broad range of options for providing evidence to demonstrate that the use of a material or product, form of construction or design meets a *Performance Requirement* or a *DTS Provision*. These are presented in the extract from the NCC reproduced below.

Alert

This Handbook has been prepared to support the use of the FSVM and most of the content is therefore focussed on that assessment method. However, it should be noted that for some applications, other *Assessment Methods* or combinations of *Assessment Methods* would be more appropriate. Refer 6.5 for further discussion on the selection of *Assessment Methods*.

The FSVM requires a comparison with a reference building that is DTS compliant and all variations from the *DTS Provisions* that fall within the scope of the FSVM and / or impact on the *Performance Requirements* addressed by the FSVM are required to be identified and considered in an assessment using the FSVM. It therefore follows that the FSVM is suited to, and appropriate for, assessing building solutions that contain a combination of *Performance Solutions* and *Deemed-to-Satisfy Solutions* relating to fire safety.

A5.2 Evidence of suitability – Volume One and Two

- (1) Subject to A5.4, A5.5 and A5.6, evidence to support that the use of a material, product, form of construction or design meets a *Performance Requirement* or a *Deemed-to-Satisfy Provision* may be in the form of any one, or any combination of the following:
- (a) A current CodeMark Australia or CodeMark *Certificate of Conformity*.
 - (b) A current Certificate of Accreditation.
 - (c) A current certificate, other than a certificate described in (a) and (b), issued by a *certification body* stating that the properties and performance of a material, product, form of construction or design fulfil specific requirements of the BCA.
 - (d) A report issued by an Accredited Testing Laboratory that—
 - (i) demonstrates that a material, product or form of construction fulfils specific requirements of the BCA; and
 - (ii) sets out the tests the material, product or form of construction has been subjected to and the results of those tests and any other relevant information that has been relied upon to demonstrate it fulfils specific requirements of the BCA.
 - (e) A certificate or report from a professional engineer or other appropriately qualified person that—
 - (i) certifies that a material, product, form of construction or design fulfils specific requirements of the BCA; and
 - (ii) sets out the basis on which it is given and the extent to which relevant standards, specifications, rules, codes of practice or other publications have been relied upon to demonstrate it fulfils specific requirements of the BCA.
 - (f) Another form of documentary evidence, such as but not limited to a *Product Technical Statement*, that—
 - (i) demonstrates that a material, product, form of construction or design fulfils specific requirements of the BCA; and

- (ii) sets out the basis on which it is given and the extent to which relevant standards, specifications, rules, codes of practice or other publications have been relied upon to demonstrate it fulfils specific requirements of the BCA.
- (2) Evidence to support that a calculation method complies with an ABCB protocol may be in the form of any one, or any combination of the following:
- (a) A certificate from a professional engineer or other appropriately qualified person that—
 - (i) certifies that the calculation method complies with a relevant ABCB protocol; and
 - (ii) sets out the basis on which it is given and the extent to which relevant standards, specifications, rules, codes of practice and other publications have been relied upon.
 - (b) Another form of documentary evidence that correctly describes how the calculation method complies with a relevant ABCB protocol.

The FSVM method adopts a holistic approach, in that an assessment undertaken using the FSVM considers all variations from a fully compliant DTS reference building that impact on the *Performance Requirements* falling within the scope of the FSVM. This includes features of the building design that may have already been the subject of a separate performance assessment including building systems that may hold current *Certificates of Accreditation* or *Certificates of Conformity* which vary from the *DTS Provisions* of the NCC.

This prevents a number of *Performance Solutions* addressing specific features of a building being used as evidence of suitability without consideration of potential interactions that could have a negative impact on fire safety within a building.

Any product or system that has previously been assessed as a *Performance Solution* can be included in a building if the FSVM is adopted, only if the combination of all variations from the NCC *DTS Provisions* are included in the NCC FSVM assessment (including those that may have already been the subject of a separate performance assessment, hold current *Certificates of Accreditation* or *Certificates of Conformity*).

This approach represents good engineering practice if other assessment methods are adopted, but it is implicitly required by the FSVM.

5 Development of a fire safety strategy

5.1 Design process

The design process for most building projects is iterative. Typically the design progresses from an initial feasibility study, through the schematic design and design development stages to design documentation. At this stage, an assessment of the design against the NCC *Performance Requirements*, using one or more assessment options, should be completed and submitted with the design documentation for regulatory approval. There are significant advantages in having a fire safety engineer (FSE) involved throughout all the above stages to capture the maximum benefit from a *Performance Solution* by allowing synergies to be exploited and practical cost-effective fire safety strategies to be developed.

The design process normally commences with defining the relevant objectives (compliance with the NCC and other non NCC objectives as appropriate), and then developing the fire safety strategy for the building taking into account the manner in which it is to be analysed using sound fire safety engineering practice.

At a fundamental level, the proper practice of fire safety engineering has a logical sequence that links each of the following:

- fire safety objectives;
- NCC Performance Requirements;
- building design/functionality concept;
- fire safety strategy;
- strategy for protection of other property;
- fire-fighting strategy;
- hazard ID and fire scenario development;
- detailed analysis;
- determination of compliance and further modifications to the strategy if necessary.

These are the fundamental elements only. There may be other important elements not listed here which must be considered.

The FSVM focusses on demonstration of compliance with the fire safety related requirements of the NCC (i.e. demonstration that the *Performance Requirements* have been satisfied). The FSVM also details the minimum fire safety related *design scenarios* to be analysed for a building and relates them to the fire safety related *Performance Requirements* for the building's proposed *Performance Solution*.

Only a minimum amount of design methodology is included in the FSVM. The intention is to set up a framework for fire safety design and not to prescribe a detailed design process which could unnecessarily discourage innovative approaches based on sound engineering principles. It is up to the FSE in conjunction with the relevant PBDB stakeholders to determine the best methodology to use for their building. The acceptance of the proposed methodology forms part of the PBDB process. For example: selecting which modelling approach is appropriate for determining the time to untenable conditions in various enclosures (e.g. hand calculations, zone models or CFD models). The following sections identify some matters that should be considered when developing a fire safety strategy in addition to compliance with NCC *Performance Requirements* to highlight the importance of adopting holistic approaches to derive cost-effective and practical solutions.

More detailed guidance in relation to development of strategies to achieve broader fire safety objectives are provided in various guides and standards including IFEG 2005^[5] and ISO 23932-1^[6].

The focus of this handbook is demonstrating compliance with the NCC *Performance Requirements* using the FSVM and the majority of the content relates to this process. Holistic approaches should be adopted during the development of a fire safety strategy to consider other legislative design constraints and client and end user objectives to derive cost-effective and practical solutions. Some general guidance for developing fire safety strategies to achieve objectives other than NCC compliance through the FSVM is provided in this chapter.

5.2 Client and end user objectives

Clients and end user objectives need to be identified and addressed and early consultation will enable a fire safety strategy to be developed that is compatible with these objectives in addition to identifying characteristics of the end users that may impact on NCC fire safety objectives.

5.3 Individual and societal risk

The NCC *Performance Requirements* and *DTS Provisions* have evolved over time in response to, amongst other things, loss of life, and tend to mirror community values and risk appetite in terms of individual and societal risk associated with specific hazards.

In the context of this Handbook, individual risk is interpreted as the frequency at which an individual may be expected to sustain a given level of harm as a result of a fire in the subject building.

The term ‘societal risk’ is often used when discussing risks from hazards that can simultaneously (or nearly so) impact large numbers of people. It is the relationship between frequency and the number of people suffering from a specified level of harm in a given population from the realisation of specified hazards. In the context of this Handbook, the “given population” is generally the population of the subject building (and adjacent buildings and surrounding land use where appropriate) unless otherwise noted and the specified hazard is a fire within or involving the subject building (and adjacent buildings and surrounding land use where appropriate).

When developing a fire safety strategy, it is necessary to consider both individual and societal risks and ensure that the proposed design adequately addresses individual and societal risks such that the fire safety level for the proposed *Performance Solution* is at least equivalent to that in a reference building that complies with the DTS NCC requirements.

5.4 Building life cycle

A typical building life cycle is shown in Figure 5.1. Design and approval decisions may impact significantly on building performance throughout the life of a building irrespective of the assessment method(s) used to demonstrate compliance with the NCC.

For example, it may be determined that a specific fire safety feature needs to be incorporated into a building. In this situation the following matters require consideration:

- How the feature will achieve its design objectives?
- How the feature can be constructed safely?
- How the feature will be commissioned, and its performance verified?
- Will the feature present a hazard during occupation of a building and if so what mitigation measures are required?
- What is the design life and how will the feature be maintained / replaced safely?
- What measures are necessary to ensure the feature does not present a hazard during renovation / modification or demolition?

Whilst some of these matters could be construed as lying outside the scope of the NCC, they are important considerations for the design team since various State and Territory Acts and Regulations, Workplace Health and Safety (WHS) and / or Fair-Trading Legislation may apply as well as a general duty of care.

The reliability of health and safety features is an important consideration which highlights the need for designers and regulatory authorities to consider matters such as commissioning / verification of compliance with the design and specification of maintenance procedures. Often this can be achieved by specification of appropriate Australian Standards or other technical specifications.

Figure 5.1 Building life cycle

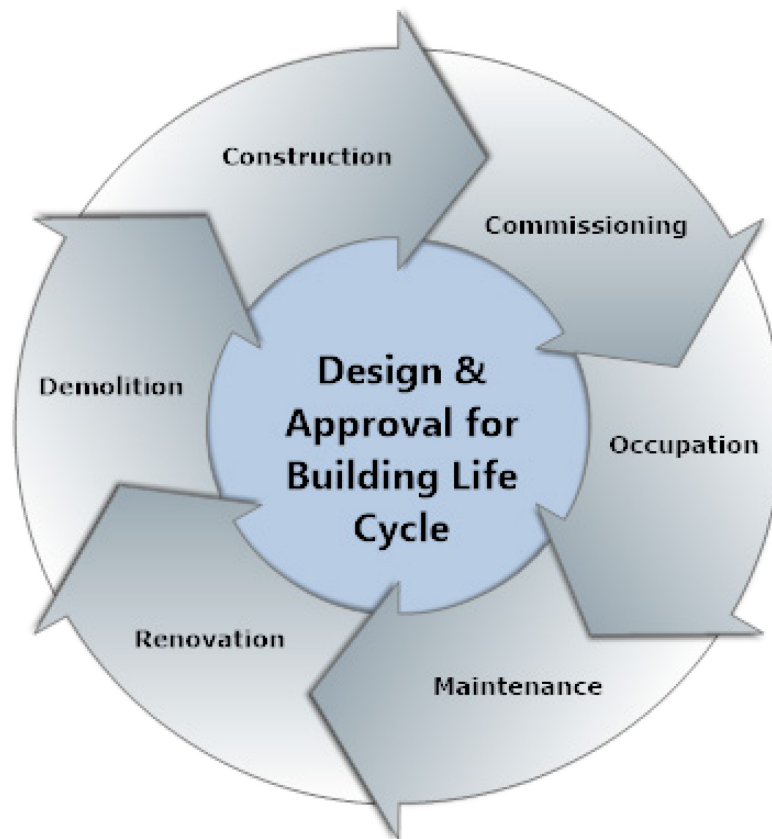

5.5 Other applicable Acts, Regulations and design responsibilities

The NCC does not regulate matters such as the roles and responsibilities of building practitioners and maintenance of fire safety measures which fall under the jurisdiction of the States and Territories.

State and Territory building legislation is not consistent in relation to these matters with significant variations with respect to:

- registration of practitioners,
- mandatory requirements for inspections during construction, and
- requirements for maintenance of fire safety measures

The design solution and approval documentation will need to address these matters.

In addition to the relevant building legislation, WHS legislation is also applicable which requires safe design principles to be applied.

A Code of Practice on the safe design of structures has been published by Safe Work Australia^[10] which provides guidance to persons conducting a business or undertaking, that designs structures that will be used, or could reasonably be expected to be used, as a workplace. It is prudent to apply these requirements generally to most building classes since they represent a workplace for people undertaking building work, maintenance and inspections at various times during the building life.

The Code of Practice defines safe design as;

“the integration of control measures early in the design process to eliminate or, if this is not reasonably practicable, minimise risks to health and safety throughout the life of the structure being designed”

It indicates that safe design begins at the start of the design process when making decisions about:

- the design and its intended purpose
- materials to be used
- possible methods of construction, maintenance, operation, demolition or dismantling and disposal
- what legislation, codes of practice and standards need to be considered and complied with.

The Code of Practice also provides clear guidance on who has health and safety duties in relation to the design of structures and lists the following practitioners:

- architects, building designers, engineers, building surveyors, interior designers, landscape architects, town planners and all other design practitioners contributing to, or having overall responsibility for, any part of the design
- building service designers, engineering firms or other designing services that are part of the structure such as ventilation, electrical systems and permanent fire extinguisher installations

- contractors carrying out design work as part of their contribution to a project (for example, an engineering contractor providing design, procurement and construction management services)
- temporary works engineers, including those designing formwork, falsework, scaffolding and sheet piling
- persons who specify how structural alteration, demolition or dismantling work is to be carried out
- In addition, WHS legislation places the primary responsibility for safety during the construction phase on the builder.

From the above it is clear that the design team in conjunction with owners / operators and the builder have a responsibility to document designs, specify and implement procedures that will minimise risks to health and safety throughout the life of the structure being designed.

A key element of safe design is consultation to identify risks, practical mitigation measures and to assign responsibilities to individuals / organisations for ensuring the mitigation measures are satisfactorily implemented.

This approach should be undertaken whichever NCC compliance pathway is adopted.

Some matters specific to health and safety are summarised below, but this list is not comprehensive.

- The NCC and associated referenced documents represent nationally recognised standards for health and safety for new building works.
- The NCC's treatment of safety precautions during construction is very limited. Additional precautions are required to address WHS requirements during construction.
- Detailed design of features to optimise reliability and facilitate safe installation, maintenance and inspection where practicable.
- Document procedures and allocate responsibilities for determining evidence of suitability for all health and safety measures.
- Document procedures and allocate responsibilities for the verification and commissioning of all health and safety measures.
- Provide details of health and safety measures within the building, evidence of suitability, commissioning results and requirements for maintenance and inspection to the owner as part of the building manual (Note: Some State and

Territory legislation contains minimum requirements for inspection of fire safety measures).

- The building manual should also provide information on how to avoid compromising fire safety through the life of a building (e.g. preventing disconnection of smoke detectors or damage to fire resistant construction).

Some health and safety measures will be impacted by other legislation that may be synergistic with the NCC requirements or potentially in conflict. These matters should be resolved as early in the design process as practicable.

5.6 Strategy development for NCC compliance

5.6.1 Objectives and *Performance Requirements*

The broad objectives of the NCC's fire safety requirements can be consolidated and expressed simply as:

- life safety of occupants
- protection of other property
- facilities for firefighting (facilitating firefighter activities)
- fire safety during construction.

It is important to note that:

Protection of the property or contents of the subject building is only addressed to a limited extent for some NCC building classes, however, protection of adjacent property is addressed more comprehensively by *Performance Requirements* relating to fire spread between buildings and considerations of disproportionate collapse. Where appropriate, consideration should also be given to the surrounding land use when assessing societal risk.

Treatment of fire safety during construction is limited and must be addressed in detail by the builder under WHS legislation.

These consolidated objectives of the NCC are expanded in more detail through the specific Objectives and Functional Statements given in the NCC and explained

further in the Guide to the NCC Volume One, but all are guidance only, as only the *Performance Requirements* of the NCC are the legislated compliance requirements.

5.6.2 Strategy for life safety

When developing a fire safety strategy to address the relevant NCC *Performance Requirements* relating to life safety, stakeholders should be cognisant that it is impractical to totally remove the risk posed by fire because as this target is approached the fire safety strategy will tend to conflict with the function and use of the building. Since the relevant *Performance Requirements* do not generally prescribe quantified criteria, the FSVM adopts an equivalency approach using the *DTS Provisions* to in effect define tolerable risk levels (community expectations).

The FSVM requires that the fire safety strategy pay close attention to the evacuation strategy to be used and the management regimes necessary to achieve the required outcomes and that the strategy is documented in the PBDB.

This is expected to;

- reduce the risk of inadvertent non-compliance with the fire safety strategy,
- provide advice on ensuring the expected reliability of fire protection systems is achieved throughout the building life,
- ensure the intended evacuation strategy for all occupants (including provision for people with disabilities) is documented and subsequently incorporated in the buildings fire safety management regime

5.6.3 Strategy for protection of other property

Protection of other property by limiting the risk of fire spread between buildings is commonly achieved by one or a combination of the following

- separation distances
- material controls to limit combustibility
- protection of openings
- use of fire-resistant construction and
- limiting the number size and configuration of openings.

The FSVM permits the use of two existing Verification Methods; CV1 and CV2; for demonstrating compliance with the *Performance Requirement* CP2(a)(iii) by setting a maximum acceptable level of radiant heat flux.

The difference between the two Verification Methods is that CV1 provides a means of demonstrating compliance to avoid the spread of fire between buildings on adjoining allotments; and CV2 provides a means of demonstrating compliance with CP2 to avoid the spread of fire between buildings on the same allotment.

The risk to other property from collapse of a structure is addressed by a combination of *Performance Requirement* CP1 and Section B of NCC Volume One.

5.6.4 Firefighter strategy

A key part of any fire safety strategy for a building is the development of a plan by which a fire brigade will;

- be notified of a fire incident and its location
- gain access to the site
- be given the correct fire incident location and communication facilities upon arrival
- be provided with documentation on the fire safety strategy to obtain a clear understanding of the strategy and form of attack for rescue and firefighting necessary
- be provided with an appropriate set up area and facilities for fire-fighting and search and rescue.

This rescue and fire-fighting strategy must be developed with the appropriate fire authority using the Fire Brigade Intervention Model (FBIM) as appropriate. The interactions of other parts of a fire safety strategy with the Fire Brigade Intervention are shown in Figure 5.2.

Figure 5.2 Stylised event tree derived from fire safety concepts tree manage fire branch

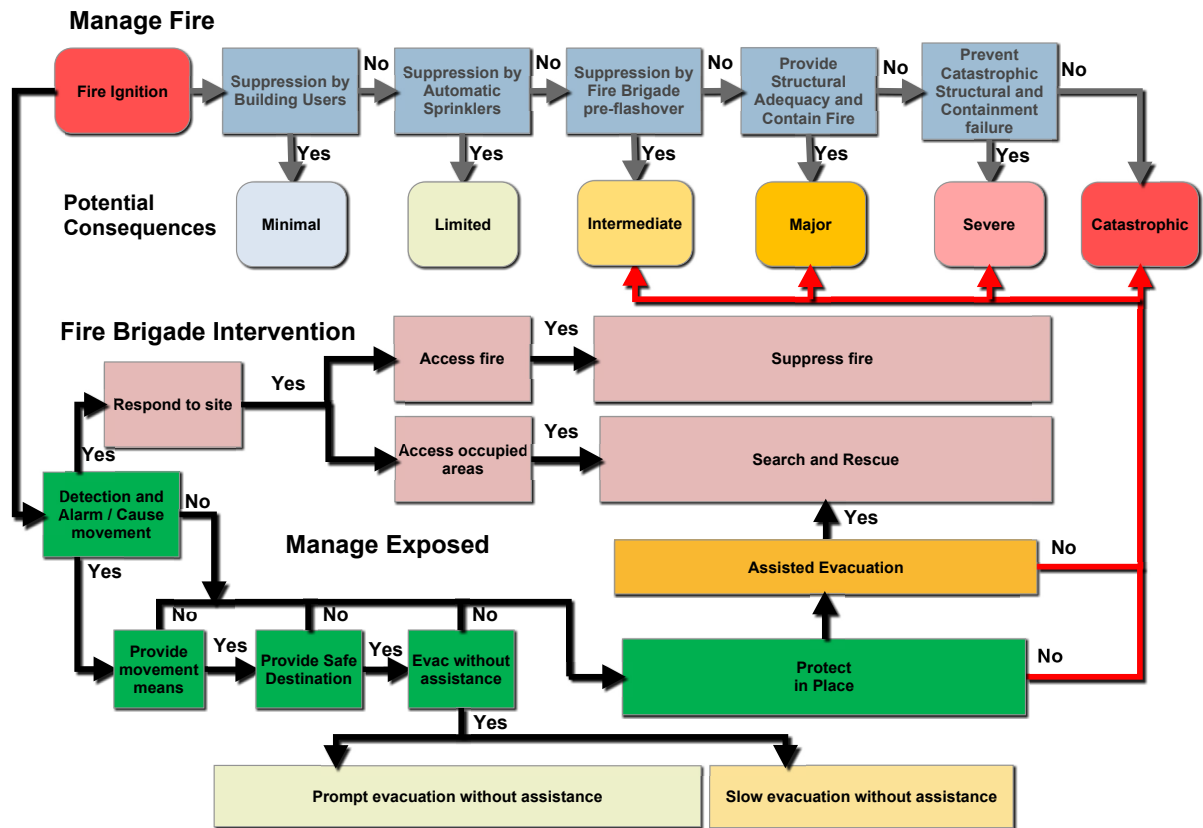

Application of the entire FBIM in every situation may not be necessary. Where minor or very specific deviations from *DTS Provisions* are proposed, the FBIM may only be required to be analysed until that aspect has been investigated and proven.

Firefighters are equipped with protective equipment and a personal breathing apparatus which increases their resistance to heat and provides protection against toxic gas exposure. The capacity of breathing apparatus should be taken into account when considering fire brigade intervention.

Tenability for firefighters should be considered based upon the exposure limits in the FBIM Manual which are summarised in Section 10.5.2 unless other criteria are derived in the PBDB process and agreed with the relevant fire authority.

5.7 Fire safety strategy documentation

The development of the fire safety strategy is iterative and an integral part of the PBDB process. Further details relating to the development of the fire safety strategy are included in subsequent sections.

At the end of the design stage the proposed *fire safety strategy* should be documented with sufficient detail to commence the assessment against the *Performance Requirements* and other nominated objectives.

The fire safety strategy should include the following;

- a summary of the fire safety objectives
- an overview of the proposed fire safety strategy outlining the philosophy and approach that will be adopted to achieve the required level of performance
- detailed drawings suitable for submission to the appropriate authority with the fire safety requirements from the FSVM highlighted to ensure that the drawings capture all the performance-based design aspects and that they will be carried through to installation, commissioning and through the remainder of the building life cycle
- occupant characteristics that the design addresses
- building characteristics including means of egress
- details of the evacuation strategy
- physical fire safety measures including method of operation and expected effectiveness (efficacy and reliability)
- fire safety management measures
- an implementation plan stating who is responsible for ensuring compliance
- required actions to ensure ongoing effectiveness of the fire safety strategy through the life of the building.

Depending on the timing of the commencement of the assessment against the NCC *Performance Requirements* and commissioning of the fire safety engineering, this documentation may be developed over a period of time involving several meetings with stakeholders or be made available at the start of the PBDB phase.

At completion it is good practice to consolidate the fire safety strategy into a draft fire safety handbook for the facility with special attention being given to the fire safety management issues such as maintenance of fire protection measures and implementation and subsequent maintenance of the evacuation strategy.

A good example is the template for a fire safety handbook has been developed by Department of Human Services Victoria^[11].

6 Performance-based design brief (PBDB) preliminaries

6.1 Overview of the PBDB

This section describes the PBDB process in the context of demonstrating compliance with the NCC although for some projects other objectives may also be considered as part of the PBDB process.

A PBDB is a documented process that (in the context of the FSVM) derives a proposed fire safety strategy and defines methods of analysis, associated inputs and acceptance criteria. Its purpose is to set down the basis, as discussed and usually agreed by the relevant stakeholders, on which the fire safety analysis of the proposed building and its *Performance Solution* will be undertaken.

It is important that at the end of the PBDB process, the proposed fire safety strategy is clearly defined such that all the relevant stakeholders have a clear expectation of the likely fire safety performance of the building and clearly understand their obligations in relation to the building project and subsequently through the building lifecycle.

While full consensus on all aspects of the PBDB is the preferred outcome, it is acknowledged that in some instances this may not be possible. If full consensus cannot be achieved, dissenting views should be appropriately recorded and carried throughout the process and considered by the *appropriate authority* when determining compliance and as part of the approvals process. Under these circumstances the *appropriate authority* and design engineer's primary responsibility is addressing life safety and being able to clearly demonstrate that compliance with the NCC and other relevant safety regulations and objectives has been achieved.

General guidance on the development of a PBDB for a fire safety project addressing the subjects listed below is presented in IFEG 2005^[5] but the fire specific term, Fire Engineering Brief (FEB), is used rather than the current general term PBDB.

- scope of project
- relevant stakeholders
- principal building characteristics
- dominant occupant characteristics
- trial designs (fire safety strategy) for assessment
- hazards and preventive and protective measures available
- general objectives
- non-compliance issues and specific objectives or *Performance Requirements*, approaches and methods of analysis
- acceptance criteria and factors of safety for the analysis
- standards of construction
- use and maintenance
- the FEB report
- fire scenarios & parameters for design fires
- parameters for design occupant groups
- standards of construction, commissioning, management, use and maintenance
- conclusion

More specific guidance relating to the PBDB process when applied to the FSVM is provided in the following sections and the process flow chart is shown in Figure 6.1.

Figure 6.1 Performance-based design brief (PBDB) process flowchart

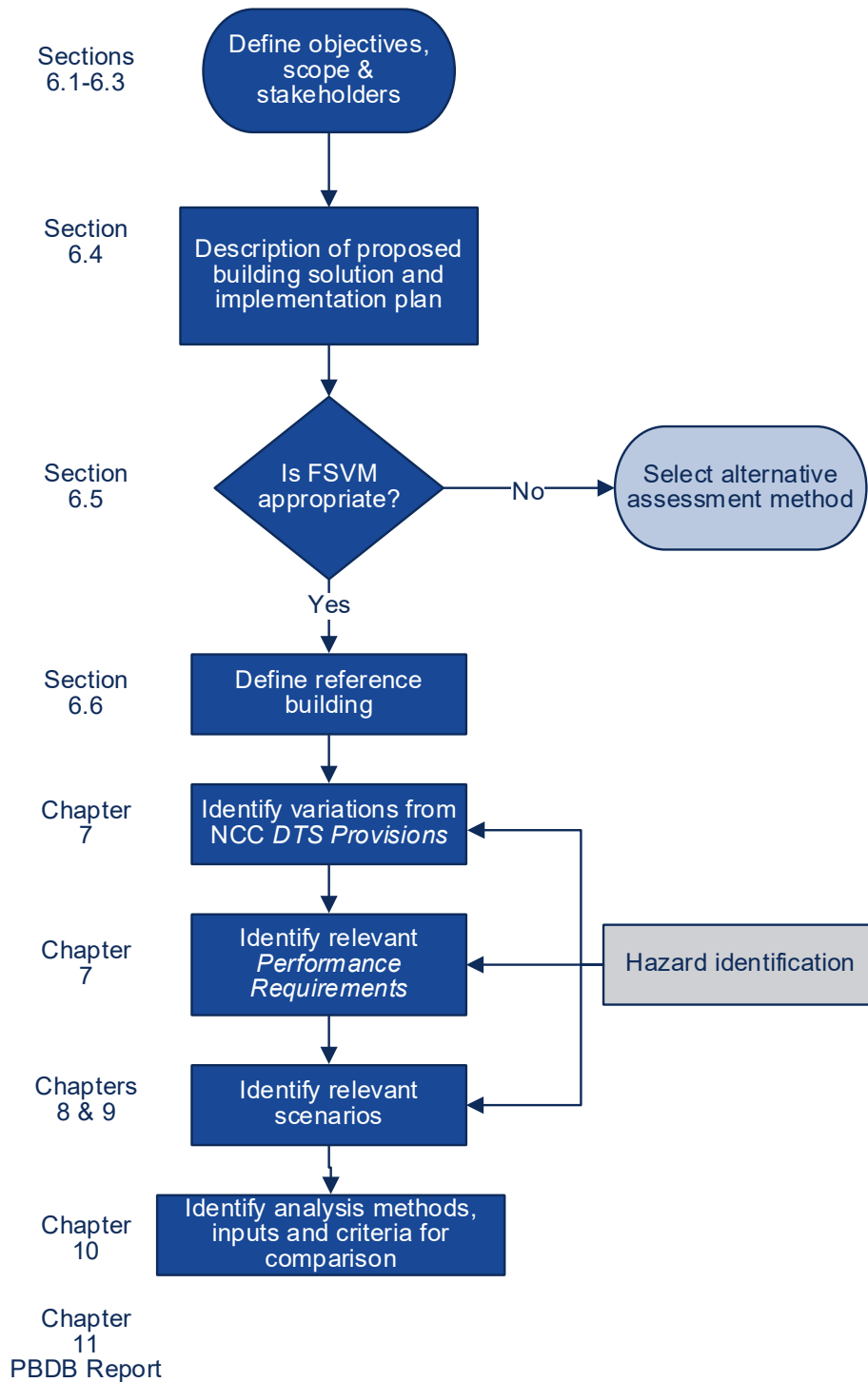

6.2 Objectives and scope

The focus of this Handbook is the application of the FSVM to develop a *Performance Solution* that complies with the NCC fire safety related *Performance Requirements* and it will be treated as the primary objective in the following sections.

However, this does not absolve the stakeholders and in particular the FSE and *appropriate authority* from a duty of care to provide and approve a fire safety design (strategy) which provides an acceptable level of safety, satisfies all relevant legislation and is fit for purpose. These additional design considerations should be clearly stated at the start of the PBDB and regularly checked as the proposed *Performance Solution* is developed to achieve a holistic and practical solution.

Typical additional design considerations may include;

- specific client and end user objectives
- consideration of fire safety and safety related to the installation, maintenance, repair, replacement and decommissioning of fire safety features through the life of the building
- State and Territory variations to the NCC in the NCC Appendices
- additional requirements specified in State and Territory Building and Planning Legislation
- WHS Regulations
- fire Safety relating to all occupants of a building if not adequately addressed through the NCC provisions
- compatibility with other NCC provisions e.g. acoustics.

Refer Section 5 for further discussion relating to objectives and scope.

6.3 Stakeholders and their role in the PBDB process

6.3.1 Selection and general role of PBDB stakeholders

The FSVM states that:

The PBDB must be developed collaboratively by the relevant stakeholders in the particular project.

The following parties must be involved:

- client or client's representative (such as project manager)
- fire engineer

- architect or designer
- various specialist consultants
- fire service (public or private)
- *Appropriate Authority* (Authority Having Jurisdiction – subject to state legislation)
- tenants or tenants' representative for the proposed building (if available)
- building operations management (if available).

Conducting a simple stakeholder analysis can be used to determine who must be involved in the PBDB process. This analysis must identify stakeholders with a high level of interest in the design process, and/or likely to be affected by the consequences of a fire should it occur in the building.

The FSVM provides clear guidance on stakeholders that must be involved in the PBDB but there are occasions when organisations have not been constituted at the time the PBDB process is being undertaken (e.g. a tenants' representative may not exist for a speculative building project).

Therefore, at the start of the process a review of relevant stakeholders should be undertaken to determine which stakeholders should be represented in the PBDB process and where appropriate who the representative should be. This review should identify stakeholders with a legitimate interest in the design process, and/or likely to be affected by the consequences of a fire should it occur in the building. Considering whether a peer review is required or not by an independent and appropriately knowledgeable FSE of the proposed *Performance Solution* and the supporting analyses, shall be undertaken at this stage. Refer Table 6.1 for further information.

The starting point for this process is the list provided in the FSVM.

The FSE responsible for developing the PBDB and undertaking the subsequent analysis should lead the PBDB process and must be involved in the stakeholder review.

Typical stakeholders / participants required by the FSVM to be involved in the PBDB process are identified in Table 6.1 together with comments relating to their participation.

Table 6.2 identifies potential supplementary stakeholders that may be required for more complex projects or where the design requires detailed examination of certain issues.

The stakeholder review process shall be fully documented by the FSE.

Table 6.1 FSVM nominated stakeholders and comments regarding involvement in the PBDB

Stakeholder	Comment
Client or client's representative (such as project manager)	If a client nominates a client's representative to act on their behalf such as the architect or project manager a written authorisation should be obtained and recorded. Direct or indirect input from the client is critical.
Architect or designer	The architect or designer is a critical stakeholder since they may be the only consultant with an oversight of the entire project. It is not appropriate for an alternate to be nominated.
Fire safety engineer (FSE)	The FSE's role is to lead the PBDB and document all findings. It is not appropriate for an alternate to be nominated.

Stakeholder	Comment
<p><i>Appropriate Authority</i> (subject to state legislation permitting the Authorities participation)</p>	<p>Irrespective of the applicable legislation in a State or Territory the <i>appropriate authority</i> is generally the body that will determine compliance with the NCC of all <i>Performance Solutions</i> including those related to fire safety and with the relevant legislation unless the matter is referred to a Board or other regulatory process that has the authority to determine compliance with the NCC. This role extends to ensuring compatibility of compliance with all NCC <i>performance requirements</i> and the fire safety performance proposal.</p> <p>Care is required to ensure the <i>appropriate authority</i> is not involved in design decisions for matters under their jurisdiction as it creates a conflict or perceived conflict of interest since in most jurisdictions the appropriate authority must be independent and act in the public interest. Once the proposed <i>Performance Solution</i> has been developed by the design team, in most jurisdictions, it is reasonable for the <i>appropriate authority</i> to provide comment at the PBDB stage in relation to matters such as;</p> <ul style="list-style-type: none"> • The suitability of proposed performance benchmarks • The suitability of the proposed analysis methods and input data • The need for a peer review • Interpretation of relevant regulations and the NCC. <p>Unless prevented from participation by regulation it is not appropriate for an alternate to be nominated.</p>
<p>Fire service (public or private)</p>	<p>The fire service plays a critical role in fire emergencies and must be involved in the FSVM PBDB irrespective of whether or not their involvement is required for the specific matters under consideration by State or Territory regulation. Depending upon staff availability and the specific fire service procedures, input may be provided by correspondence. Unless prevented from participation by regulation or fire service procedures it is not appropriate for an alternate to be nominated. If for any reason the fire service did not participate in the PBDB the reasons should be fully documented together with evidence of the request made to the fire service.</p>

Stakeholder	Comment
Tenants or tenants' representative for the proposed building	If a tenant's representative body has been established at the time the PBDB is undertaken participation should be requested in writing. If the tenants' body does not exist or does not wish to participate input on behalf of their interests will normally be provided by the architect or other nominated member of the design team with appropriate knowledge of the potential tenants' interests.
Building operations management (if available).	If a building operations manager, safety officer or other person with responsibility for safety and operations within the completed building has been appointed at the time the PBDB is undertaken, participation should be requested in writing. If building operation and safety personnel have not been appointed at the time of the PBDB input on behalf of their interests will normally be provided by the WHS expert, the architect, or other nominated member of the design team with appropriate knowledge.
Various specialist consultants	Modern buildings can have very large consultant teams and depending upon the specifics of a project they may need to participate in all or part of the PBDB process. Either an architect who has overall control of a project or a project manager with this responsibility are best placed to coordinate the involvement of other stakeholders in consultation with the FSE. Some of the more relevant specialist disciplines are discussed further in Table 6.2

Table 6.2 Supplementary stakeholders and comments regarding involvement in the PBDB

Stakeholder	Comment
Peer reviewer	For more complex FSVM projects it may be decided to seek a peer review. Since a peer reviewer will assist the <i>appropriate authority</i> determine compliance with the NCC and other relevant legislation. Care is required to ensure the peer reviewer is not involved in design decisions as it creates a conflict or perceived conflict of interest. Once the proposed <i>Performance Solution</i> has been developed by the design team, in most jurisdictions, it is reasonable for the appropriate authority and therefore the peer reviewer to provide comment at the PBDB stage in relation to matters such as the suitability of proposed performance benchmarks, the proposed analysis methods and input data.
Regulations consultant	If the <i>appropriate authority</i> is unable to participate due to legislation, a building surveyor should be engaged as a stakeholder or the role of a regulations consultant may be undertaken by a specialist regulation consultant (e.g. WHS expert) or other delegated member of the design team having appropriate expertise. The person responsible for providing design consultancy with respect to regulations should be clearly identified in the PBDB report.
Structural engineer	Close liaison with the project structural engineer is likely to be required to consider the potential behaviour of the structure when evaluating scenarios such as SS (structural stability) and UF (unexpected catastrophic failure)
Access consultants	Access consultants may be required to assist with the development of appropriate egress provisions for people with disabilities
Services engineers	Service engineers may be required for projects where the design of fire services and / or active smoke management systems are being considered as part of a <i>Performance Solution</i> .
Acoustic engineers	Acoustic engineers may be required for projects where the design of passive fire protection and acoustic systems are being integrated or to provide information on the likely audibility of alarms on the opposite side of an acoustic wall, for example.

6.3.2 Peer review process

Where *Performance Solutions* are more complex, have innovative designs, or challenging aspects of modelling or analysis which fall outside the competence and expertise of the *appropriate authority* and/or fire service reviewers, consideration should be given at the PBDB review stage to the appointment of a peer reviewer.

The peer reviewer should have qualifications and experience which gives them a level of competence equal to or better than the original design FSE in order to evaluate the *Performance Solution* proposed.

In the context of reviewing the work of another engineer, the peer review is potentially the most complex kind of review both technically and ethically. The purpose of peer review can include comment on some or all of the following:

- whether the completed work has met the objectives set out for it;
- other options for methods of analysis and scenarios that could have been included in the fire engineering brief process (note care needs to be taken not to be involved in the design / derivation of the *Performance Solutions* (fire safety strategy) to maintain independence and impartiality);
- whether the evaluation of options is robust and fair;
- the validity of the assumptions;
- ensure that the PBDB process has been followed in the analysis and conclusions;
- check the validity of the approach, methodology, analysis (including design parameters and software tools) and conclusions;
- the validity of any recommendations;
- adherence to relevant regulations and codes of practice; and
- the fitness for purpose of the work.

Whilst the peer reviewer may participate in design meetings (if permitted by relevant State or Territory Regulations) the input they provide should be consistent with input provided by the *appropriate authority* to avoid creating a conflict or perceived conflict of interest.

While the work is in progress, the peer reviewer can review inputs at specified points, to aid the design process and avoid problems such as poor evaluation of options and incorrect assumptions.

The peer reviewer shall have no vested interest in the project or direct relationship with the FSE. Access to the FSE by the peer reviewer is however, important. An ethical consideration arises for the peer reviewer when there are concerns with the design. The peer reviewer should contact the FSE and the appropriate authority to indicate any differences between the peer reviewer's documentation and the FSE's design before the peer reviewer issues a report. This allows the FSE to comment and state a position before the report is submitted. The peer reviewer's role is to identify areas of the design that need to be addressed and to invite the FSE to resolve them to the peer reviewer's satisfaction. The peer reviewer should not become involved in resolving the issues.

The peer reviewer should submit an official report detailing their comments on the PBDB and the final report.

6.3.3 Coordinating the PBDB process

Not all stakeholders will be able to contribute equally or be available to contribute. The reality of many projects means that often a draft PBDB is prepared by the FSE submitted for comment to the other stakeholders, then refined and approved based on the feedback from the stakeholders. The circumstances of each project and the method by which it will receive its regulatory approval will generally dictate the precise process to be used and how many meetings (face-to-face, telephone, teleconferencing, etc.) are held.

6.4 Description of the proposed fire safety strategy

The derivation of a proposed fire safety strategy and requirements for documenting the design are described in Section 5. This information will generally be sufficient to determine if the FSVM is the most appropriate assessment method for NCC compliance for the *Performance Solution*. If the FSVM is adopted, additional

information relating to NCC *DTS Provisions* and for hazard identification purposes may be required.

6.5 Selection of Assessment Methods for determining the *Performance Requirements* have been satisfied

The FSVM is most suited to *Performance Solutions* where a similar reference building complying with the NCC *DTS Provisions* can be identified that provides, in the view of the stakeholders, a reasonable benchmark for comparison.

Whilst input from all stakeholders is desired the onus for this decision will generally fall on the FSE, *appropriate authority*, fire services and peer reviewer if appointed.

It should be noted that there may be situations where other assessment options within the NCC are more appropriate. A good example of this would be a large cold store which due to its size and height of stored goods would require sprinkler protection as an NCC *DTS Solution*.

Example: Large cold store with an impractical automatic fire sprinkler system

A large cold store, which due to its size and height of stored goods would require sprinkler protection if a *DTS Solution* is specified. It could be argued that the provision of sprinkler protection is impractical due to the additional cost to provide a system capable of operating below freezing and if such a system was provided its reliability could be considerably less than a standard sprinkler system operating at temperatures above the freezing point and additional hazards could be introduced upon activation of the sprinkler system (e.g. ice production on floors increasing the risk of slips, trips and falls). A *Performance Solution* will therefore be considered.

Under these circumstances it is reasonable for the PBDB team to consider a 'first principles / absolute' approach to demonstrate the relevant *Performance Requirements* have been satisfied rather than the FSVM 'comparative approach' because additional slips trips and fall hazards would apply to a sprinkler protected reference building.

Note; with a 'first principles / absolute' approach it is necessary to derive quantified criteria with respect to both the required efficacy and reliability of the *Performance Solution*.

The FSVM can be used for the assessment of minor performance scenarios where there is minimal interaction between fire safety sub-systems, such that most of the scenarios prescribed by the FSVM are not relevant. For most minor performance scenarios though, the FSVM process is likely to be excessive in respect to the level of detail required. Other assessment methods may be more practicable to adopt since they can focus on necessary scenarios without the need to review all the prescribed scenarios. A typical example of this involving wall and ceiling linings is included in Section 9.7 Example 3.

6.6 Derivation of reference building

Using the building description and fire safety strategy (refer Section 5.7) as a starting point it is necessary to define a *reference building* based on a *DTS Solution* to provide a benchmark for comparison.

The selection of an appropriate *reference building* is critical since it is the basis of quantifying acceptance criteria with respect to both individual risk and societal risks. This is therefore one of the most important tasks for the PBDB team to ensure that the reference building provides a satisfactory benchmark. The basis for the selection must be clearly documented in the PBDB.

The following principles have been prepared to assist with the selection of a *reference building* and any departures from these should be identified and fully justified in the PBDB:

Principles for selection of a reference building

The reference building should;

- be fully compliant with the NCC *DTS Provisions* including relevant State or Territory variations nominated in the NCC appendices.
- comply with other relevant variations to the NCC *DTS Provisions* specified in relevant State or Territory Acts or Regulations. These must be clearly stated in the PBDB including reference to the legislation.
- have the same footprint, floor area and volume as the proposed building.
- be of the same NCC Class(es) as the proposed building.
- have the same effective height as the subject building.
- require the same Type of Construction as the subject building (based on Clause C1.1 of the NCC).
- have the same occupant numbers and same occupant characteristics as the subject building.
- have the same basic fire load and design fire characteristics (ignition sources and fuel properties) as the subject building (these basic characteristics may be then modified based on the variations from the *DTS Provisions* applicable to the subject building).
- be located the same distance from the boundary or other fire source feature as the subject building.
- have the same size and configuration of openings in external walls.
- have a similar general internal layout (except for identified variations from *DTS Provisions*).
- have the same fire brigade response and arrival time after notification as the subject building.
- have similar configurations of hidden voids, openings and ducts, ventilation and air-movement as the subject building unless these are specific features of the *Performance Solution* under consideration.
- where there are options for fire protection measures, adopt a combination of measures based on sound engineering principles that would be expected to provide an acceptable level of safety.
- be specified in sufficient detail to enable all deviations from the *DTS Provisions* for the subject building to be identified.
- if appropriate, include additional features that may not be addressed or fully addressed through adoption of the current NCC *DTS Provisions*. E.g. provisions for the evacuation of people with disabilities or use of lifts for evacuation.

Recording acceptance of the reference building

The *reference building* indirectly defines acceptable individual and societal risk levels. The PBDB report must therefore include a confirmation that the full consensus of the PBDB stakeholder representatives was that the reference building provides a reasonable benchmark for assessing the fire risks associated with the subject building. If there are any dissenting views these should be recorded and considered by the *appropriate authority* when determining if the *Performance Solution* satisfies the *Performance Requirements*.

It is highly recommended that every effort is made to resolve any dissenting views prior to proceeding with further analysis.

Particular attention needs to be given to the impact the selection of the subject building can have on societal risk which may not be apparent based on a superficial review.

This is best demonstrated by the following example of an apartment building where an extension of the maximum travel distance of 6 m (DTS requirement) to 12 m (part of a *Performance Solution*) from an apartment door to a fire-isolated stair is to be considered.

Example: Selection of a reference building layout to consider an extended travel distance from a SOU door to a fire isolated stair (single stair)

The layout for the subject building (proposed *Performance Solution*) is shown in Figure 6.2.

Following the principles stated above, the footprint of the building and general layout should be maintained along with the number of occupants, which would effectively require the same number of apartments.

This yields a layout similar to that shown in Figure 6.3 which requires two stairs to be provided under a *DTS Solution*. Therefore, the proposed variation is an increase in travel distance AND a deletion of an exit which has a significant impact on the selection of scenarios and potential outcomes.

Figure 6.2 Subject building (Proposed Performance Solution)

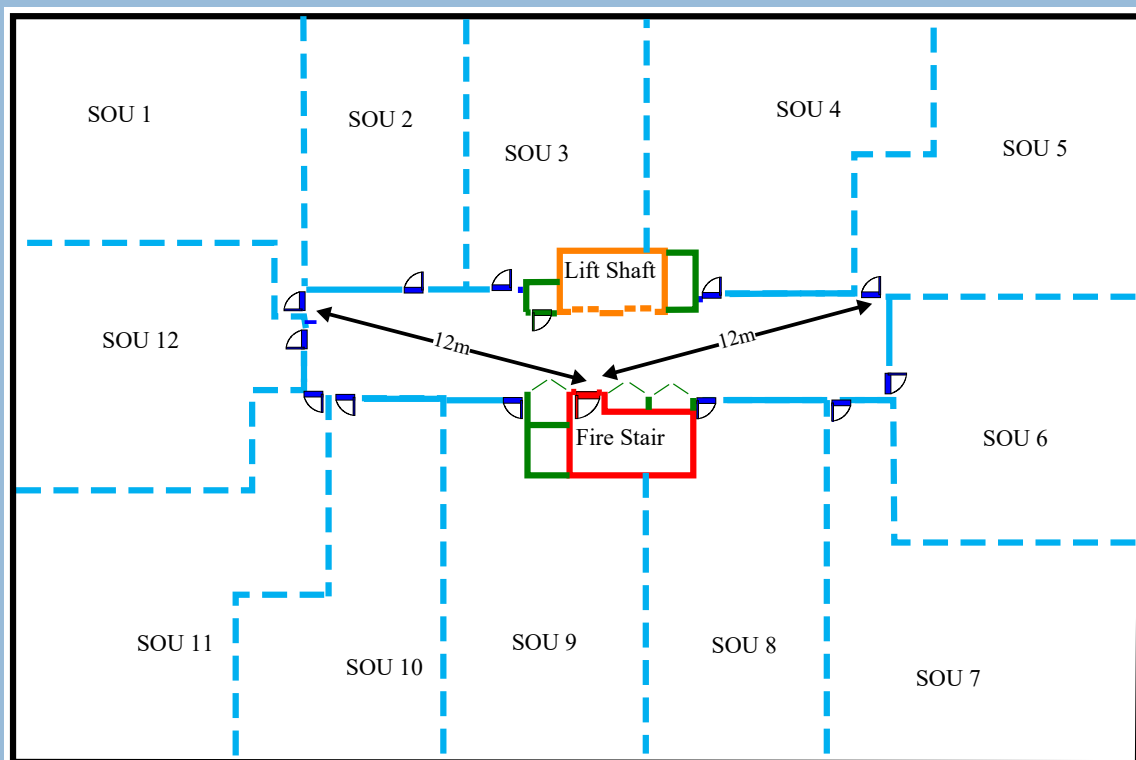

If a *reference building* had been proposed with a single stair and maximum travel distance of 6 m as shown in Figure 6.4, the population and footprint would have changed (in conflict with the Principles for Selection of a *reference building*) but there would only be a single exit from each level. If this was used as a *reference building* and compared to the subject building shown in

Figure 6.2, the population at risk in the subject building would be double that of the reference building and also there would be a doubling of the number of fire starts within the building having a significant impact on societal risk.

Figure 6.3 Reference building (two fire stairs required)

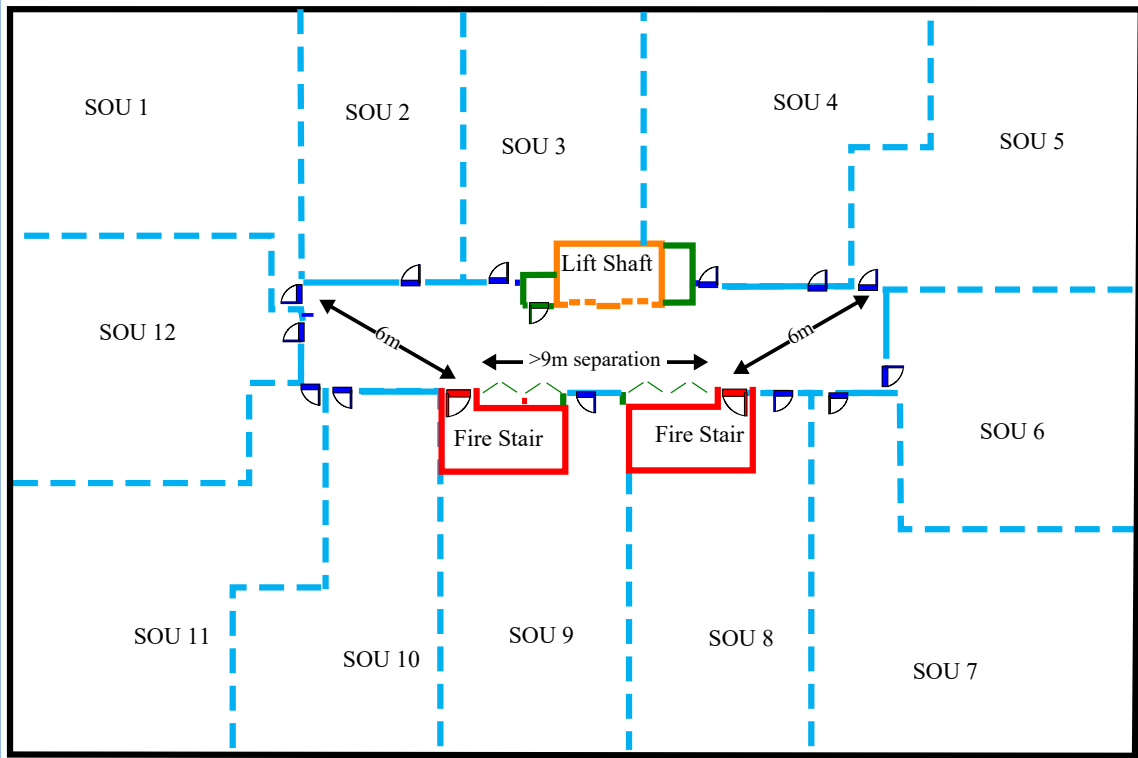
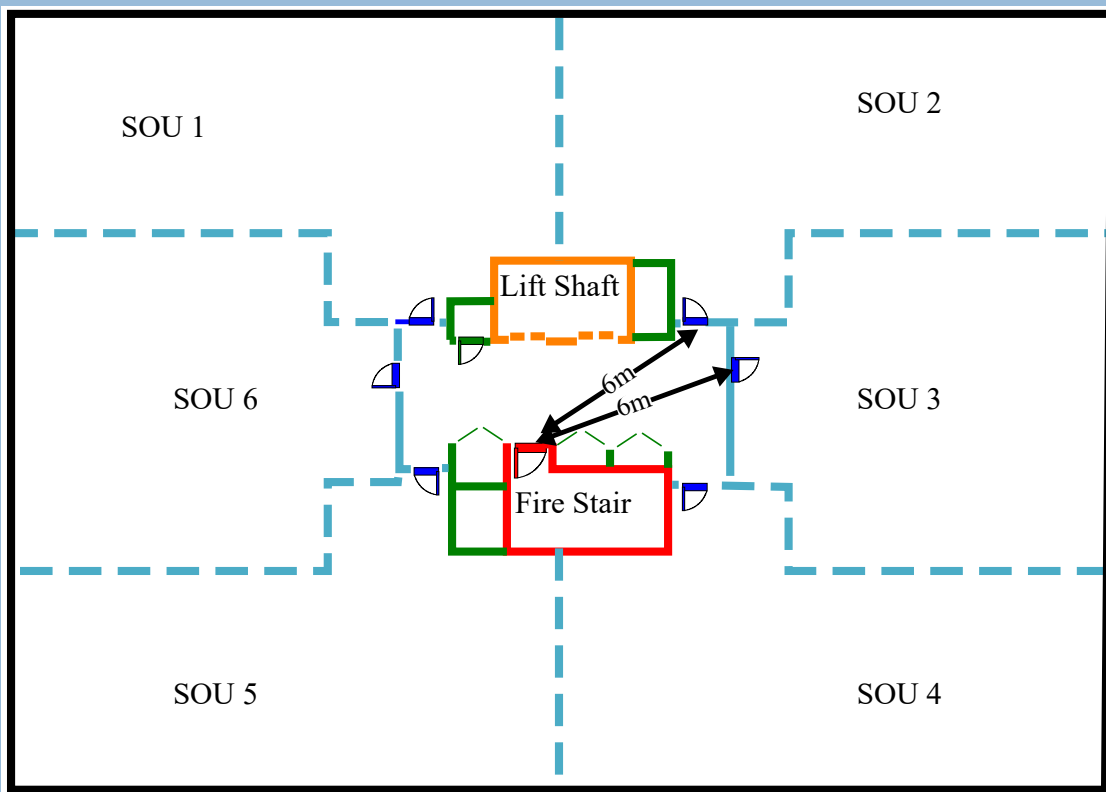

Figure 6.4 Reference building varying from the principles for selection of a reference building



For innovative buildings where the current *DTS Provisions* may not manage fire risks efficiently there are two options available to the PBDB stakeholders:

- nominate additional features (in addition to a *DTS Solution*) for the reference building that in the view of the PBDB will provide an appropriate benchmark for the innovative building, or
- not use the FSVM and instead adopt a first principles approach to demonstrate compliance of a *Performance Solution* with the *Performance Requirements*.

An example of this type of building would be an ultra-high rise building where enhancements such as those summarised below may be appropriate;

- enhancements to address egress for people with disabilities which can be integrated with enhancements to general egress provisions by means of:
 - additional protect in place / partial evacuation strategies
 - use of lifts for evacuation
 - provision of dedicated lifts for fire-fighters and
 - enhanced sprinkler protection to increase reliability
 - enhancements to the structural design to reduce the risk of disproportionate collapse.

7 Identification of departures from NCC *DTS Provisions* and related *Performance Requirements* that may be affected

Once the PBDB stakeholders have agreed on the reference building, a systematic comparison with the proposed fire safety strategy (*Performance Solution*) should be undertaken to identify all building design elements and related *Performance Requirements* where the NCC *DTS Provisions* are not met.

The approach to identification of the relevant *Performance Requirements* is consistent with clauses A2.2(3) and A2.4(3) of the NCC which is reproduced in Chapter 2 of this Handbook.

A schedule of the *DTS Provisions* that are not met should be prepared and included in the PBDB report.

The schedule should include the following for each variation;

- Identification of the relevant NCC *DTS* clause(s)
- A description of the scope of non-conformity with *DTS Provisions*
- A description / reference to the locations in the building where *DTS* non-conformity occurs
- *Performance Requirements* from the same sections or parts of the NCC that are relevant to the identified *DTS Provisions*.
- *Performance Requirements* from other sections or parts of the NCC that are relevant to any aspects of the proposed *Performance Solution* or that are affected by the application of the *DTS Provisions* that are the subject of the *Performance Solution*.

To assist with the identification of *Performance Requirements* from other fire related sections and parts, the matrix in Table 7.1 has been prepared. The filled circles indicate where a *Performance Requirement* specifically nominates a parameter for consideration and the unfilled circles indicate parameters for consideration where the content of the *Performance Requirement* implies that the parameter should be considered. For example, the evacuation time is a function of the number, mobility /

occupant characteristics and travel distance and therefore where one of these parameters have been nominated by implication the other parameters also apply.

In the row to the right of each *Performance Requirements*, the parameters for consideration are indicated. By checking the column for each parameter for consideration it is possible to identify other *Performance Requirements* that may also be affected. Whether the other *Performance Requirements* are relevant to a *Performance Solution* will vary with the specifics of the variations to the reference building design being considered.

The matrix is expected to assist practitioners apply a systematic approach to identifying other relevant *Performance Requirements*, but it is important that the practitioners consider each project on a case by case basis and do not rely solely on the matrix.

Extracts from *Performance Requirements* CP1 and BP1.1 are presented below;

CP1 Structural stability during a fire

A building must have elements which will, to the degree necessary, maintain structural stability during a fire appropriate to— ...

BP1.1 Structural reliability

- (a) A building or structure, during construction and use, with appropriate degrees of reliability, must—
 - (i) perform adequately under all reasonably expected design actions; and
 - (ii) withstand extreme or frequently repeated design actions; and
 - (iii) be designed to sustain local damage, with the structural system as a whole remaining stable and not being damaged to an extent disproportionate to the original local damage; and

- (iv) avoid causing damage to *other properties*, by resisting the actions to which it may reasonably expect to be subjected.
- (v) (b) The actions to be considered to satisfy (a) include but are not limited to—

BP1.1(a)(iii) has relevance to CP1 and may be critical when considering the following scenarios:

- RC – Robustness Check
- SS – Structural Stability
- FI – Fire Brigade Intervention
- UF – Unexpected Catastrophic failure

Table 7.1 Matrix of fire safety *Performance Requirements*, parameters for consideration (PC) and FSVM scenarios

Performance Requirement	PC - function or use of the building	PC- fire load	PC- potential fire intensity;	PC- fire hazard;	PC- height of the building / num. of storeys	PC- its proximity to other property	PC- any active fire safety systems	PC- size of any fire compartment / floor area	PC- fire brigade intervention	PC- other elements they support	PC- evacuation time	PC- Number, mobility / occupant charact.	PC- travel distance	PC- Exit above or below ground	PC- Fire Safety System	BE – Blocked Exit	UT – Unoccupied Enclosure fire	CS – Concealed Space	SF – Smouldering Fire	IS – Internal Surfaces	CF – Challenging Fire	RC – Robustness Check	SS – Structural Stability	HS – Horizontal Spread	VS – Vertical Spread	FI – Fire Brigade Intervention	UF – Unexpected Catastrophic failure
	CP1	●	●	●	●	●	●	●	●	●	●	●	○	○		○	✓	✓	✓	✗	✗	✓	✓	✓	✗	✗	✓
CP2	●	●	●	●	●	●	●	●	●	●	●	○	○		○	✓	✓	✓	✓	✓	✓	✓	✗	✓	✓	✓	✓
CP3	○	○	○	○			○		○		○				○	✓	✓	✓	✓	✗	✓	✓	✗	✗	✗	✗	✗
CP4	●						●				●	●	○		○	✗	✗	✗	✗	✓	✗	✗	✗	✗	✓	✗	✗
CP5		○	○	○	○											✗	✗	✗	✗	✗	✗	✗	✓	✗	✓	✗	✗
CP6		○	○	○												✗	✗	✗	✗	✗	✗	✗	✗	✗	✗	✗	✗
CP7	○	○	○	○			○									✗	✗	✗	✗	✗	✗	✗	✓	✗	✓	✓	✗
CP8	○	○	○	○	○	○	○	○	○	○	○					✓	✓	✓	✓	✗	✓	✓	✓	✗	✓	✗	✗
CP9	●	●	●	●			●	●	●							✗	✗	✗	✗	✗	✓	✓	✓	✗	✗	✓	✓
DP4	●				●						○	●	●	●		✓	✓	✓	✓	✓	✓	✓	✗	✗	✗	✗	✗
DP5	●				●				●						●	✓	✓	✓	✓	✓	✓	✓	✗	✗	✗	✓	✗
DP6	●										○	●	●			✓	✗	✓	✓	✓	✓	✓	✗	✗	✗	✗	✗
DP7	●				●						○	●	●		●	✓	✗	✗	✗	✗	✗	✓	✗	✗	✗	✗	✗
EP1.1	●			●				●							●	✗	✗	✗	✓	✓	✓	✓	✗	✗	✗	✗	✗
EP1.2	●			●											●	✗	✗	✗	✓	✗	✓	✓	✗	✗	✗	✗	✗
EP1.3				●				●	●							✗	✗	✗	✓	✗	✓	✓	✗	✗	✗	✓	✗
EP1.4	●	○		●	●			●	○							✓	✓	✓	✓	✓	✓	✓	✗	✗	✗	✓	✗
EP1.6	●				●			●								✗	✗	✗	✗	✗	✗	✗	✗	✗	✗	✓	✗
EP2.1							○									✓	✓	✓	✓	✓	✓	✓	✗	✗	✗	✗	✗
EP2.2	●	●	●	●	○		●		●		○	●	●	○	○	✓	✓	✓	✓	✓	✓	✓	✓	✗	✓	✓	✗
EP3.2					○			●								✗	✗	✗	✗	✗	✗	✗	✗	✗	✗	✓	✗
EP4.1	●							●					●			✓	✓	✓	✓	✓	✓	✓	✗	✗	✗	✗	✗
EP4.2								○				○	○			✓	✓	✓	✓	✓	✓	✓	✗	✗	✗	✗	✗
EP4.3	●				●			●								✓	✓	✓	✓	✓	✓	✓	✗	✗	✗	✗	✗

8 Process for identification and development of scenarios

8.1 Identification scenarios required by FSVM for consideration

The FSVM lists *design scenarios* that must be considered as a minimum for the relevant *Performance Requirements* identified during the hazard identification process. The table below is a reproduction of FSVM Table 1.2.

FSVM Table 1.2 list of *Performance Requirements* and the relevant *Design Scenario*

Performance Requirement	Design scenario
CP1	BE, UT, CS, FI, UF, CF, RC, SS
CP2	BE, UT, CS, SF, HS, IS, FI, CF, RC, UF, VS
CP3	BE, UT, CS, SF, CF, RC
CP4	IS, VS
CP5	FI, SS
CP6	CS
CP7	FI, VS
CP8	BE, UT, CS, SF, CF, RC, VS
CP9	FI, UF
DP4	BE, UT, CS, SF, IS, CF, RC
DP5	BE, UT, CS, SF, IS, FI, CF, RC
DP6	BE, CS, SF, IS, CF, RC
DP7	BE, RC
EP1.1	SF, IS, CF, RC
EP1.2	SF, CF, RC
EP1.3	SF, FI, CF, RC
EP1.4	BE, UT, CS, SF, IS, CF, RC
EP1.6	FI
EP2.1	BE, UT, CS, SF, IS, CF, RC
EP2.2	BE, UT, CS, SF, IS, FI, CF, RC, VS

Performance Requirement	Design scenario
EP3.2	FI
EP4.1	BE, UT, CS, SF, IS, CF, RC
EP4.2	BE, UT, CS, SF, IS, CF, RC
EP4.3	BE, UT, CS, SF, IS, CF, RC

These *design scenarios* are also identified in the matrix shown in Table 7.1 for convenience with a green tick indicating that consideration of the *design scenario* is required and a red cross where the design scenario is not identified as requiring consideration.

These tables are provided to assist practitioners apply a systematic approach to identifying relevant *design scenarios*, but it is important that the practitioners consider each project on a case by case basis and do not rely solely on the tables because they may be interactions between *Performance Requirements* and scenarios that are specific to the proposed *Performance Solution* and *Reference Building* under consideration.

An overview of the *design scenarios* is provided in Table 8.1 which has been adapted from Table 1.1 of the FSVM Summary of *design scenarios*.

Reference should be made to Section 9 for more detailed guidance on the individual fire scenarios.

Table 8.1 Summary of *design scenarios*

<i>Design scenario</i>	Performance Requirement	Typical method or solutions	Outcome required
BE – Blocked Exit A fire blocks an <i>evacuation route</i>	CP1, CP2, CP3, CP8, DP4, DP5, DP6, DP7 ¹ , EP1.4, EP2.1, EP2.2, EP4.1, EP4.2, EP4.3	Demonstrate that a viable <i>evacuation route</i> (or multiple routes where necessary) has been provided for building occupants.	Demonstrate that the level of safety be at least equivalent to the <i>DTS Provisions</i> ,

<i>Design scenario</i>	Performance Requirement	Typical method or solutions	Outcome required
<p>UT - Unoccupied Enclosure Fire</p> <p>A fire starts in a normally unoccupied room and can potentially endanger a large number of occupants in another room</p>	<p>CP1, CP2, CP3, CP8, DP4, DP5, EP1.4, EP2.1, EP2.2, EP4.1, EP4.2, EP4.3</p>	<p>ASET / RSET analysis or provide separating construction or fire suppression complying with a specified Standard. Solutions might include the use of <i>separating elements</i> or fire suppression to confine the fire to the room of origin.</p>	<p>Demonstrate that the level of safety be at least equivalent to the <i>DTS Provisions</i>.</p>
<p>CS - Concealed Space</p> <p>A fire starts in a concealed space that can facilitate fire spread and potentially endanger a number of people in a room</p>	<p>CP1, CP2, CP3, CP6, CP8, DP4, DP5, DP6, EP1.4, EP2.1, EP2.2, EP4.1, EP4.2, EP4.3</p>	<p>Solution might include providing separating construction or fire suppression or <i>automatic</i> detection complying with a specified Standard</p>	<p>Demonstrate that fire spread via concealed spaces will not endanger occupants. Demonstrate that the level of safety be at least equivalent to the <i>DTS Provisions</i>.</p>
<p>SF – Smouldering Fire</p> <p>A fire is smouldering in close proximity to a sleeping area</p>	<p>CP2, CP3, CP8, DP4, DP5, DP6, EP1.1, EP1.2, EP1.3, EP1.4, EP2.1, EP2.2, EP4.1, EP4.2, EP4.3</p>	<p>Solution might provide <i>automatic</i> detection and alarm system complying with a recognised Standard.</p>	<p>Demonstrate that the level of safety be at least equivalent to the <i>DTS Provisions</i>.</p>
<p>IS – Internal Surfaces</p> <p>Interior surfaces are exposed to a growing fire that potentially endangers occupants.</p>	<p>CP2, CP4, DP4, DP5, DP6, EP1.1, EP1.4, EP2.1, EP2.2, EP4.1, EP4.2, EP4.3</p>	<p>ASET / RSET analysis or equivalent growth and species production rates.</p>	<p>Maintain tenable conditions to allow time for evacuation of occupants and to facilitate fire brigade intervention; and demonstrate that the level of safety be at least equivalent to the <i>DTS Provisions</i>.</p>

<i>Design scenario</i>	Performance Requirement	Typical method or solutions	Outcome required
CF – Challenging Fire Worst credible fire in an occupied space	CP1, CP2, CP3, CP8, DP4, DP5, DP6, EP1.1, EP1.2, EP1.3, EP1.4, EP2.1, EP2.2, EP4.1, EP4.2, EP4.3	ASET / RSET analysis.	Demonstrate that the level of safety be at least equivalent to the <i>DTS Provisions</i> .
RC – Robustness Check Failure of a critical part of the fire safety systems will not result in the design not meeting the Objectives of the NCC	CP1, CP2, CP3, CP8, DP4, DP5, DP6 DP7, EP1.1, EP1.2, EP1.3, EP1.4, EP2.1, EP2.2, EP4.1, EP4.2, EP4.3	Modified ASET / RSET analysis.	Demonstrate that if a key component of the fire safety system fails, the design is sufficiently robust that a disproportionate spread of fire does not occur (e.g. ASET / RSET for the remaining floors or fire compartments is satisfied); and demonstrate that the level of safety be at least equivalent to the <i>DTS Provisions</i> .
SS – Structural Stability Building does not present risk to other properties in a fire event	CP1, CP5, CP9, EP1.4	Undertake analysis of structure and fire safety systems	Demonstrate that the building does not present an unacceptable risk to other property due to collapse or barrier failure resulting from a fire; and demonstrate that the level of safety be at least equivalent to the <i>DTS Provisions</i> .
HS – Horizontal Spread A fully developed fire in a building exposes the external walls of a neighbouring building	CP2	CV1. CV2.	NA (refer CV1 and CV2)

<i>Design scenario</i>	<i>Performance Requirement</i>	<i>Typical method or solutions</i>	<i>Outcome required</i>
VS –Vertical Spread A fire source exposes a wall	CP2, CP4, CP7, CP8 and EP2.2	CV3	NA (refer CV3 and CV1 and CV2 as appropriate)
FI – Fire Brigade Intervention Consider <i>fire brigade</i> intervention	CP1, CP2, CP5, CP7, CP9, DP5, EP1.3, EP1.6, EP2.2, EP3.2	Facilitate fire brigade intervention to the degree necessary.	Demonstrate consideration of potential fire brigade intervention; and demonstrate that the level of safety be at least equivalent to the <i>DTS Provisions</i> .
UF – Unexpected Catastrophic Failure A building must not unexpectedly collapse during a fire event	CP1, CP2, CP9, EP1.4	Undertake review or risk assessment of critical elements within a building to determine unexpected catastrophic failure is unlikely.	Demonstrate that the building, its critical elements and the <i>fire safety system</i> provide sufficient robustness such that unexpected catastrophic failure is unlikely; and demonstrate that the level of safety be at least equivalent to the <i>DTS Provisions</i> .

Note 1: There are currently no *DTS Provisions* for the use of lifts during a fire emergency but a *Performance Requirement* (DP7) is included in the NCC

8.2 Deriving reference *design scenarios*

The prescribed *design scenarios* are specified in the FSVM in qualitative terms since the number of locations, fire characteristics and frequency of the scenarios will vary depending upon the buildings under consideration, nature of the DTS non-conformity, scope being considered and adopted methods of analysis.

The FSVM provides a general description of the *design scenario* and from these it is necessary to undertake a systematic review (Hazard ID process) to derive scenario clusters from which a number of reference *design scenarios* are identified for quantification and detailed analyses.

In order to quantify each reference *design scenario* for evaluation, it is necessary to;

- derive a design fire,
- define the status and impact of active and passive fire protection features impacting on the scenario,
- define occupant characteristics (if required) and
- determine comparative acceptance criteria having regard for the required outcome specified in the *design scenario*.

For some *design scenarios*, it will also be necessary to estimate the frequency of occurrence if it varies between the proposed *Performance Solution* and the *reference building*.

There are various hazard identification techniques or combinations of techniques that can be applied to further develop the scenarios including:

- Check lists
- What If Analysis
- Hazard Identification (HAZID)
- Hazards and Operability Analysis (HAZOP)
- Failure Mode and Effects Analysis (FMEA)
- Literature review / review of historic record.

These may be structured or relatively informal. It is important that the process is rigorous but with the opportunity for free thinking to identify potentially significant low probability high consequence events and therefore a mix of structured and informal processes is recommended involving as a minimum the key stakeholders and any peer reviewers.

The depth and complexity of the hazard identification process required will vary depending on the building features being considered but as a minimum it should systematically consider the prescribed *design scenarios* in various building locations with appropriate design fires, occupant characteristics and combinations of fire safety measures effectively identifying clusters of scenarios which then can be consolidated into a number of reference scenarios for detailed analysis. The number of reference scenarios will depend on the selected method(s) of analysis and ability to identify a critical, or a series of potentially critical, reference scenarios. In some instances, for each prescribed scenario, reference scenarios with design fires in a number of different building locations may require evaluation.

Conversely the Hazard ID process may identify that some of the prescribed fire scenarios are not applicable to the *Performance Solution* under consideration. For example, many NCC building classifications do not include sleeping accommodation (e.g. offices, retail premises factories etc.) and therefore the SF scenario will not require further consideration.

If the building has some innovative or unusual features, additional scenarios, to those prescribed by the FSVM may be identified and require evaluation. The hazard identification process enables the need for additional scenarios to be evaluated for buildings with innovative or unusual features.

The PBDB report should provide a clear explanation of:

- the derivation of reference scenarios and other parameters for the FSVM prescribed scenarios.
- a full justification for setting aside fire scenarios prescribed by the FSVM if they are not considered relevant to *Performance Solution* under consideration
- the basis for adding additional scenarios and the derivation of the reference scenarios.

Further details of the derivation of reference scenarios for each of the prescribed FSVM *design scenarios* are provided in Chapter 9.

8.3 Deriving design fires

It is common to subdivide a design fire into the following four stages with a typical example shown in Figure 8.1.

- incipient
- growth
- fully developed; and
- decay.

Figure 8.1 Design fire stages and interventions

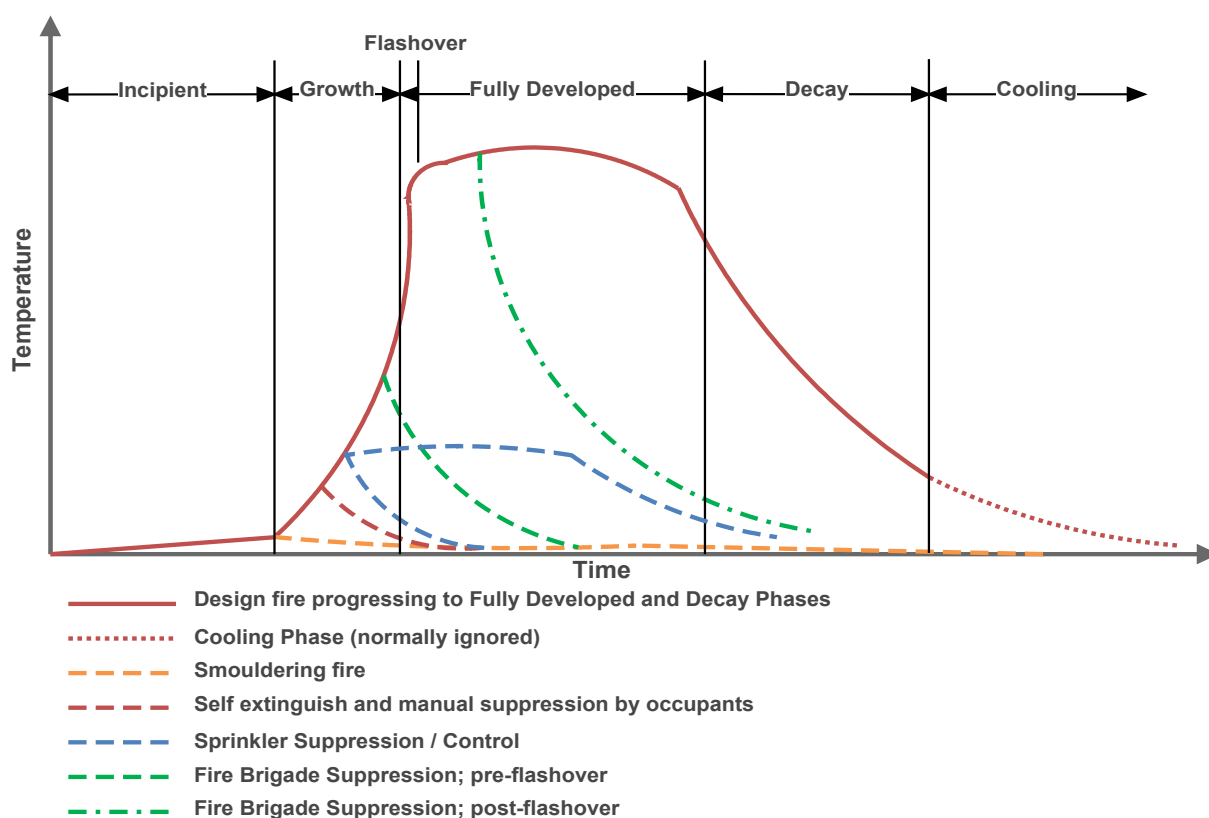

A cooling phase after combustion has effectively ceased has been included in Figure 8.1 but this is normally ignored. Also shown is a smouldering fire scenario that does not progress to the growth phase and various interventions by occupants, fire brigade and automatic suppression / control systems (e.g. sprinklers).

Design fires are generally defined by one or more of the following parameters:

- fire growth rate;
- peak heat release rate (HRR);
- fire load energy density;
- species production (water, soot);
- heat flux;
- duration;
- the position of the fire;
- ventilation conditions; and
- enclosure boundary conditions.

The frequency of a design fire occurrence is commonly derived by published fire incident data, but it should be noted that many smouldering and small flaming fires

are dealt with by the occupants and therefore go unreported. It is common to consider reported fires only and ignore suppression by occupants and self-extinguishment of small fires.

The design fire is then modified for automatic or fire brigade intervention as appropriate for the *design scenario*.

Further details relating to the derivation of design fires and characteristic inputs are available for download from the ABCB website (abcb.gov.au).

General information relating to the selection of design fire scenarios and design fires is provided in ISO 16733-1^[4].

8.4 Deriving occupant characteristics / scenarios

The variability of occupant behaviour and differing response capabilities mean that the required safe egress time (RSET) should be a stochastic distribution due predominately to variations in pre-movement times and travel speeds.

In some situations, it may be possible to characterise the stochastic distribution as occupant scenario clusters and then quantify these as a series of reference occupant scenarios that can be applied to individuals or groups of occupants as necessary. Example 2 below is a typical example with the reference scenarios being;

- Prompt evacuation without assistance
- Slow evacuation without assistance
- Assisted evacuation (i.e. pre-movement time ∞ unless assisted).

RSET is the calculated time available between ignition of the design fire and the time when all the occupants in the specified room, location, and other affected spaces have left that room, location, and other affected spaces.

In general, *RSET* is determined using the following (or a similar) relationship:

$$RSET = (t_d + t_n + t_{pre}) + (t_{trav} + t_{flow})$$

where:

- t_d = *detection time* determined from deterministic modelling
- t_n = time from detection to notification of the occupants
- t_{pre} = time from notification until evacuation begins
- t_{trav} = time spent moving toward a place of safety, and
- t_{flow} = time spent in congestion controlled by flow characteristics.

The relationship is shown in a graphical form in Figure 8.2.

Figure 8.2 Graphical representation of RSET / ASET analysis

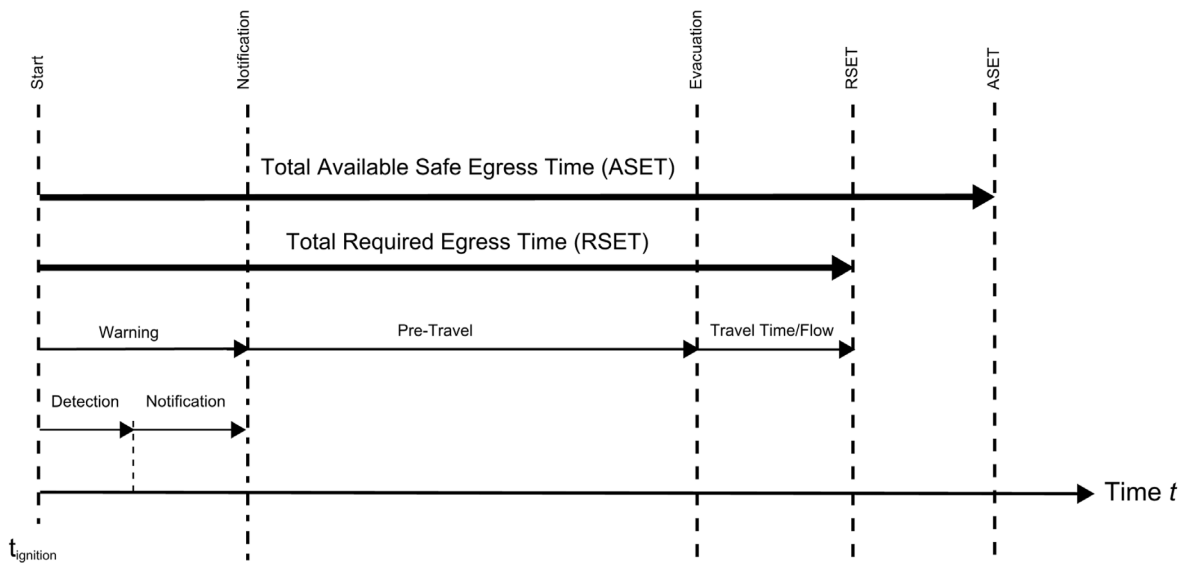

The extent to which occupant characteristics need to be quantified will depend on the *design scenario*, methods of analysis and nature of the variation from the reference buildings.

Typical examples are provided below.

Example 1 Proposed Performance Solution and reference building with the same occupant characteristics, detection and alarm system and egress provisions

Under these circumstances the approach proposed by Babrauskas^[12] may be appropriate whereby the RSET is assumed to be the same for the *Performance*

Solution and reference building and in lieu of an RSET / ASET analysis it is only necessary for a comparative study to compare ASET values.

Example 2 Proposed Performance Solution and reference building with the same occupant characteristics, but differing detection and alarm system and egress provisions

The approach proposed by Babrauskas^[16] requires some modification for this problem because the detection time, notification time and travel and flow times differ but the most subjective variable (pre-travel) is the same.

In this instance rather than consider the full stochastic distribution it was considered appropriate to consider “three clusters” of design pre-movement times each yielding a representative pre-movement time for the comparative analysis as detailed below:

- prompt evacuation without assistance
- slow evacuation without assistance
- assisted evacuation (i.e. pre-movement time ∞ unless assisted).

Probabilities could be assigned to each of the clusters or analysis undertaken for each reference pre-movement time representing a cluster. If all the results indicate the same ranking between the *Performance Solution* and reference building no further analysis may be required provided there were no indications of a potential for the rankings to change at values between the reference values adopted.

Further details relating to the derivation of design occupant characteristics are available for download from ABCB website (abcb.gov.au).

General information relating to the selection of occupant scenarios is provided in ISO /TR 16738:2009^[13] and ISO / TS 29761:2015^[14].

9 Derivation of reference scenarios from FSVM prescribed scenarios

This chapter presents specific information relating to the FSVM prescribed *design scenarios* which are summarised in Table 9.1 and selection of appropriate quantitative performance criteria for comparison of the proposed *Performance Solution* and reference building. The performance criteria will depend on the extent of the variations between the buildings, methods of analysis and reference scenarios and must be agreed with stakeholders during the PBDB process.

Table 9.1 Overview of fire scenarios

Ref	Design scenario	Design scenario description
BE	Fire blocks <i>evacuation route</i>	A fire blocks an <i>evacuation route</i>
UT	Fire in a normally unoccupied room threatens occupants of other rooms	A fire starts in a normally unoccupied room and can potentially endanger a large number of occupants in another room
CS	Fire starts in concealed space	A fire starts in a concealed space that can facilitate fire spread and potentially endanger a large number of people in a room
SF	Smouldering fire	A fire is smouldering in close proximity to a sleeping area
IS	Fire spread involving internal finishes	Interior surfaces are exposed to a growing fire that potentially endangers occupants
CF	Challenging fire	Worst credible fire in an occupied enclosure
RC	Robustness check	Failure of a critical part of the <i>fire safety systems</i> will not result in the design not meeting the Objectives of the BCA
SS	Structural stability and other properties	Building does not present risk to other properties in a fire event
HS	Horizontal fire spread	A <i>fully developed fire</i> in a building exposes the external walls of a neighbouring building
VS	Vertical fire spread involving cladding or arrangement of openings in walls	A fire source exposes a wall and leads to significant vertical fire spread

Ref	Design scenario	Design scenario description
FI	Fire brigade intervention	Facilitate fire brigade intervention
UF	Unexpected catastrophic failure	A building must not unexpectedly collapse during a fire event

9.1 Design scenario (BE): Blocked exit

9.1.1 Intent

To determine, if the fire risk to occupants resulting from a blocked evacuation path for the proposed *Performance Solution* is less than or equal to the reference building.

9.1.2 Background

The NCC *DTS Provisions* recognise that it is not practical to provide multiple escape paths from all points within a building. This is reflected by the NCC provisions that typically prescribe a maximum distance of travel to an exit or a point from which travel in two directions to two different exits (i.e. a maximum dead-end distance is prescribed).

The NCC *DTS Provisions* also have additional requirements for minimum and maximum distances between exits and minimum separation between paths of travel to exits to further reduce the risk from blocked exits.

9.1.3 Derivation of reference scenarios and performance criteria

Potential fire source locations that prevent the use of exits in evacuation routes should be identified.

Fire characteristics (e.g. HRR) and analysis need not be considered in all cases as the fire is assumed to physically block the *evacuation route* and it may be assumed that occupant tenability criteria cannot be met where fire plumes and flames block an *evacuation route*. However, there may be potential scenarios where, for example, a

developing fire may initially block one *evacuation route* and as the fire grows block an alternative *evacuation route*, in which case it will be necessary to consider the fire characteristics.

The derivation of reference scenarios is demonstrated in the following examples:

Example 1 Derivation of reference scenarios for analysis of multistorey building of Type A construction with one exit

The example building is multi-storey office building with a single exit stair from each level discharging directly to open space. Each floor may be open plan or split into a number of SOUs which do not need to be separated by fire resistant or smoke resistant construction.

Note: In this context the term SOU (Sole-occupancy unit) means a room or other part of a building for occupation by one or joint owner, lessee, tenant, or other occupier to the exclusion of any other owner, lessee, tenant, or other occupier and includes a room or suite of associated rooms in a Class 5, 6, 7, 8 or 9 building and should not be confused with an SOU in a Class 2 or 3 building which requires fire resistant bounding construction

The typical layout is shown in Figure 9.1. In this example the PBDB process identifies two scenario clusters one occurring at the bottom of the fire isolated exit stair and the other close to the entrance to the stair on a typical floor with several independently leased small offices (SOUs).

Scenario cluster at the base of the stair

Whilst fire isolated stairs and passageways should not be used for storage (and there are limited ignition sources) there are cases particularly at ground level where fire isolated stairs have been used to store rubbish / furnishings or combustibles are introduced and ignited maliciously. This occurs sufficiently frequently that a reference scenario should be considered.

Figure 9.1 Selection of design scenarios for blocked exit (BE) single stair

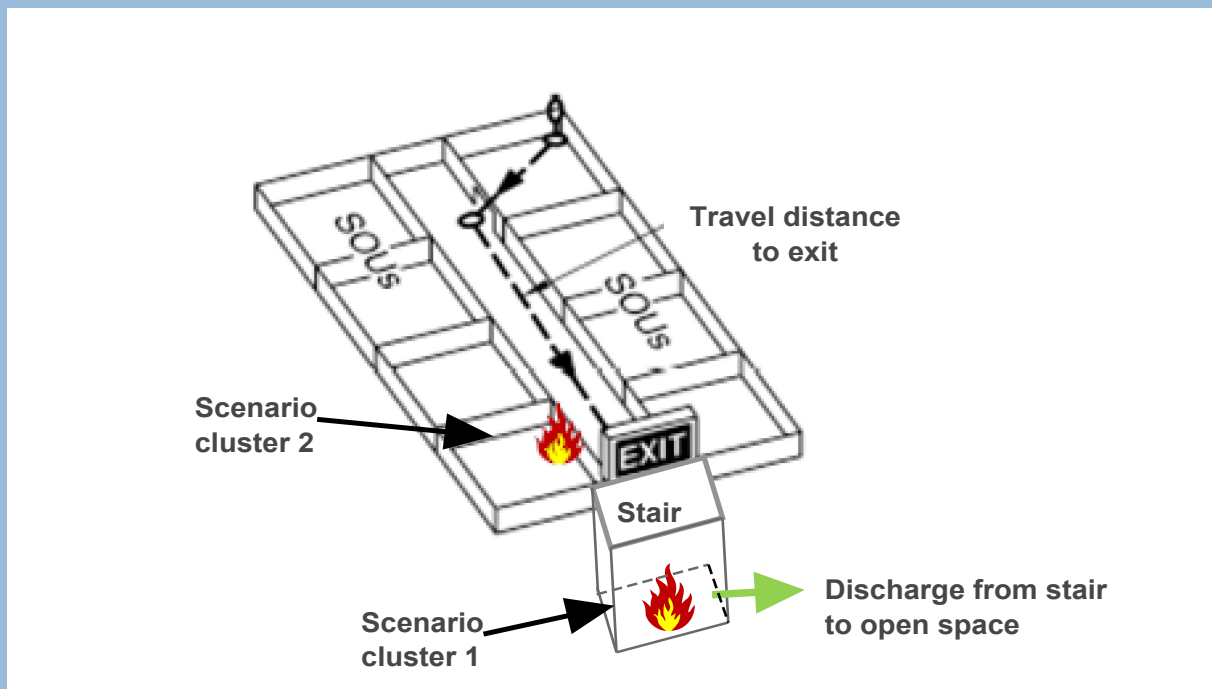

The PBDB process identified an arson attack as a credible reference scenario involving the introduction and ignition of a cardboard boxes progressing to a rapidly developing fire that is likely to block the stair before any occupants can evacuate. However, it was determined that the fire resistance and lining properties for both building solutions are similar and such that the derived design fire would not spread to involve the linings and the fire and products of combustion would be contained within the stair to such a degree that fire spread from the stair would not occur and occupants would only have the potential to be exposed to untenable conditions if they tried to evacuate through the stair. For this reference scenario it is not necessary to fully define the design fire. The performance criteria could be based on the number of people trapped within the building (i.e. the building population) and if appropriate consideration of the frequency of the scenario occurring. For example, security and management of the building could have a significant impact on the frequency of arson attacks. Alternatively based on the PBDB and management systems intended for the building the PBDB process may determine that the risk of occupants trying to escape through a smoke logged stair is sufficiently low for both building solutions that further analysis is not warranted.

Note: if the *Performance Solution* features an extension of travel distance, the reference building selected is likely to have two stairs and the proposed *Performance*

Solution one stair, which would be difficult to demonstrate equivalence without the inclusion of additional measures such as automatic fire sprinklers to reduce the risk for the *Performance Solution*.

Scenario cluster close to entry to stair and SOU on a typical level:

The PBDB process identified a fire occurring close to the entrance of an SOU and also close to the entrance of the fire-isolated exit as a reference scenario (fast t^2 design fire assumed) because this could block egress from the SOU of fire origin quickly and, slightly later, the path of travel for all occupants from the floor of fire origin to the stair. If there is no automatic fire suppression in the reference building and proposed *Performance Solution*, the fire will be assumed to progress to flashover with smoke leakage around the fire door to the stair potentially preventing evacuation from floors above the fire floor if the evacuation was not complete. For this reference scenario it is necessary to fully define the design fire.

The selected performance criteria are very much dependent on the similarity between the reference building and proposed *Performance Solution*.

An ASET / RSET type analysis may be adopted with direct exposure to radiant heat close to the fire or direct flame contact presenting the initial tenability criteria before lack of visibility. A series of comparisons can be made for;

- (a) Occupants within the SOU of fire origin (either the margin of safety or number of people exposed to untenable conditions).
- (b) Occupants on the floor of fire origin (either the margin of safety or number of people exposed to untenable conditions).
- (c) Occupants on floors above the floor of fire origin (either margin of safety or numbers trapped on the floor above).

Where the occupant profiles and numbers are similar and detection / alarm systems are also similar, the analysis could be simplified by consideration of ASET avoiding the need to specifically consider the variability of human behaviour.

If the proposed *Performance Solution* applies a sprinkler protection strategy that is not required for the reference building and depending upon the extent of the

variation, a general qualitative analysis supported by fire data on the effectiveness of sprinklers and a frequency analysis may be sufficient to satisfy the PBDB stakeholders.

Example 2 Derivation of reference scenarios for analysis of multistorey building of Type A construction with two exits

The example building is a multi-storey office building with two exit stairs from each level discharging directly to open space. Each floor is divided into a number of SOUs which do not need to be separated by fire resistant or smoke resistant construction.

The typical layout is shown in Figure 9.2. In this example, the PBDB process initially identifies two scenario clusters one occurring at the bottom of a fire-isolated exit stair and the other close to the entrance to a SOU in the middle of the floor plan. A review of the ground floor layout indicated that the potential for a single fire to compromise both exits on the ground floor was unlikely and the second stair provided an alternative evacuation path if a fire was set in one of the stairs. It was therefore determined that only the scenario cluster of a fire occurring close to the entrance to a SOU in the middle of the floor plan required evaluation.

The PBDB process identified a fire occurring close to the entrance of a SOU midway between the two exits was an appropriate reference scenario (fast t^2 design fire assumed) because this could block egress from the SOU of fire origin quickly and smoke spread to the central corridor would reduce visibility preventing access to the stairs from other SOUs if evacuation had not been completed. Therefore, it is necessary to fully define the design fire. If there is no automatic fire suppression in the reference building and proposed *Performance Solution*, the fire will be assumed to progress to flashover with smoke leakage around the fire doors to the stairs preventing evacuation from floors above the fire floor if the evacuation was not complete.

Figure 9.2 Selection of design scenarios for BE two stairs

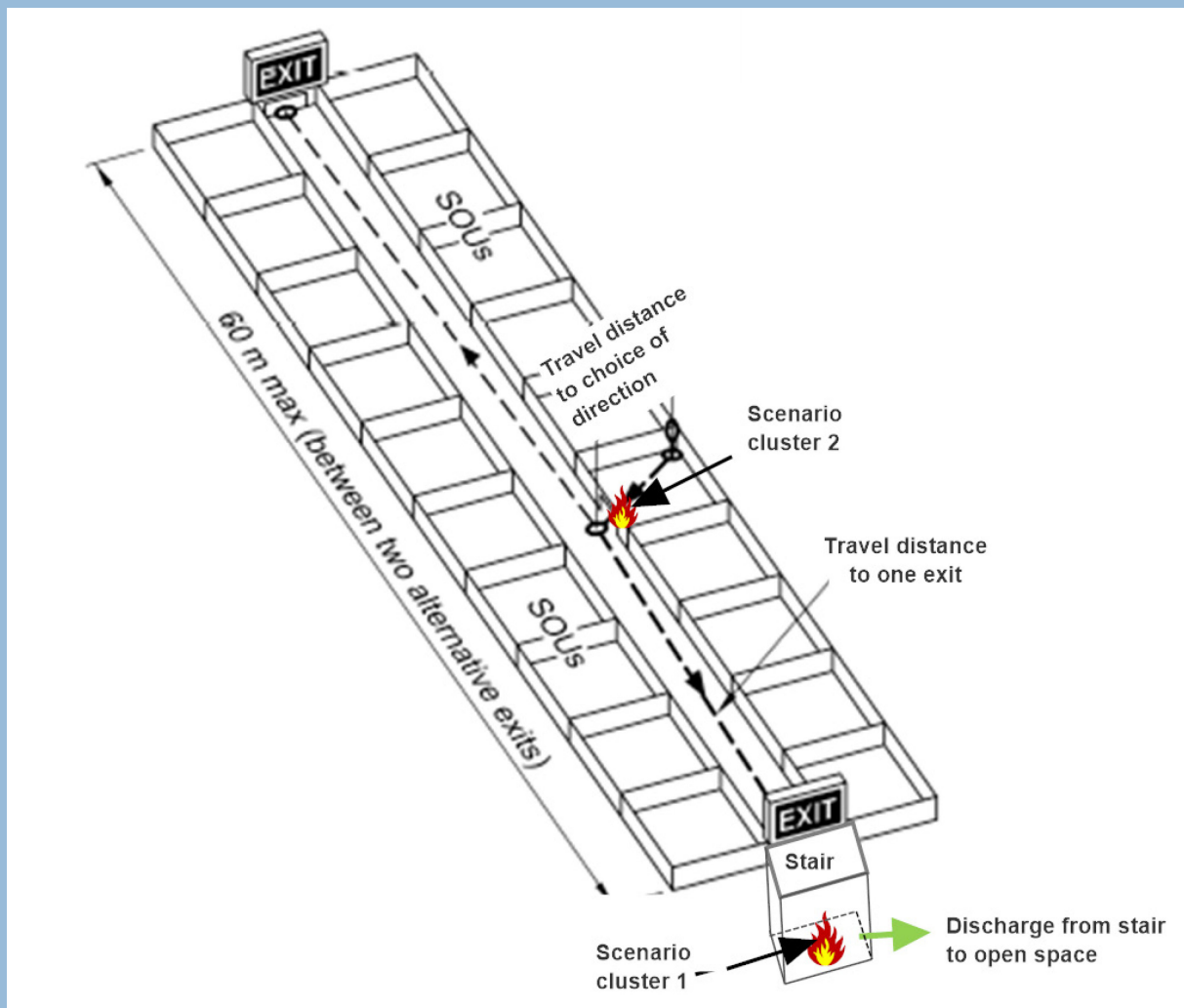

The selected performance criteria are very much dependent on the similarity between the reference building and the proposed subject building including the *Performance Solution*.

An ASET / RSET type analysis may be adopted with direct exposure to radiant heat close to the fire or direct flame contact presenting the initial tenability criteria before lack of visibility. A series of comparisons can be made for the following adopting a similar approach to Example 1;

- (a) Occupants within the SOU of fire origin (either the margin of safety or number of people exposed to untenable conditions).
- (b) Occupants on the floor of fire origin (either the margin of safety or number of people exposed to untenable conditions).

- (c) Occupants on floors above the floor of fire origin (either margin of safety or numbers trapped on the floor above).

9.1.4 Typical mitigation measures

Typical mitigation measures may include:

- provision of an alternative exit;
- reducing distances of travel to an exit or choice of exit;
- controlling ignition sources and fire loads close to paths of travel to exits;
- automatic suppression systems.

9.2 Design scenario (UT): Normally unoccupied room

9.2.1 Intent

To determine if the fire risk to occupants, resulting from a fire in a normally unoccupied room for the proposed *Performance Solution*, is less than or equal to the reference building.

9.2.2 Background

This *design scenario* only applies to buildings with rooms or spaces that could be threatened by a fire occurring in another normally unoccupied space such as storage rooms, service rooms, and cleaning cupboards. It is not intended to address fires located in kitchenettes, toilets, staff rooms, or meeting rooms or other rooms or spaces that are normally occupied but may be temporarily unoccupied to which Scenario CF (challenging fire) would apply in lieu of Scenario UT.

Examples of rooms or spaces that could be threatened include:

- rooms or spaces physically adjacent to the unoccupied room;
- rooms or spaces that are remote and are not fire or smoke separated; or
- rooms or spaces through which occupants have to pass that could be caused to be untenable by a fire in an unoccupied room or space.

A fire starting in an unoccupied space can grow to a significant size undetected and then spread rapidly to other areas where people may be present or spread to evacuation routes.

It must be assumed that the building is fully occupied at the time of the fire and evacuation of all people must be addressed (i.e. consider prompt and slow unassisted evacuation and assisted evacuation if appropriate). Active and passive fire safety systems in the building are required to be assumed to perform as intended by the design.

9.2.3 Derivation of reference scenarios and performance criteria

During the Hazard ID process, all unoccupied spaces should be identified in the proposed *Performance Solution* and reference building.

For each space consideration should be given to the following amongst other things when determining design scenario clusters and subsequently reference scenarios:

- proximity to occupied areas and evacuation paths,
- potential paths for spread of fire and smoke,
- potential design fires based on contents and ignition sources within the normally unoccupied space,
- active and passive fire protection systems that could impact on fire and smoke spread and / or alert occupants and
- the number, location and evacuation capabilities and means of evacuation available to occupants.

This scenario can present a significant risk when a fire can grow to a significant size undetected and then spread rapidly to other areas where people may be present or have no alternative but to use that space as an evacuation route.

Design fires should be derived from consideration of matters such as the contents of the unoccupied area and likely ignition sources, size, internal surfaces and construction of the room boundaries. Unless the unoccupied space is protected by a detection system supplemented by an alarm to alert occupants, no response should

be assumed until the fire or significant smoke breaks out of the enclosure into an occupied space and the occupants recognise the fire cues or a detector in another space and associated alarm is activated.

Design scenario clusters should be identified, and one or more reference scenarios derived for detailed analysis.

Appropriate performance criteria are very much dependent on the similarity between the reference building and proposed *Performance Solution* and method of analysis.

If an ASET / RSET type analysis is adopted, a series of comparisons can be made for:

- (a) Occupants within enclosures occupying adjacent enclosures threatened by the design fire (either the margin of safety or number of people exposed to untenable conditions could be adopted as performance criteria).
- (b) Other occupants trapped on the floor of fire origin due to all appropriate evacuation paths being compromised.

Where the occupant profiles and numbers are similar the comparison and alarm systems are also similar the analysis could be simplified by consideration of ASET avoiding consideration of the variability of human behaviour.

If the reference building does not require automatic sprinkler protection, but sprinkler protection is provided as an additional mitigation method for a proposed *Performance Solution*, depending upon the extent of the other variations from the *reference building* a generally qualitative analysis supported by fire data on the effectiveness of sprinklers and a frequency analysis may be sufficient to satisfy the PBDB stakeholders but in other circumstances a detailed quantitative analysis is likely to be required.

9.2.4 Typical mitigation measures

If fire spread from unoccupied spaces is found to present a greater risk for the *Performance Solution* compared to the *reference building* typical mitigation measures may include:

- relocation of the unoccupied space, egress pathway or similar adjustment of the building layout;
- provision or extension of a current detection and alarm system to provide early detection and alarm, potentially supplemented by fire and / or smoke separation of the unoccupied area;
- provision of an automatic sprinkler protection system.

9.3 Design scenario (CS): Concealed space

9.3.1 Intent

To determine, if the fire risk to occupants resulting from a fire in a concealed space in the proposed *Performance Solution* is less than or equal to the reference building.

The FSVM also requires an additional check for this *Design Scenario* that requires that fire spread via concealed spaces will not endanger occupants located in other rooms / spaces. For this check it is appropriate to assume that all active and passive fire safety systems in the building will perform as intended by the design and the evacuation will be undertaken as intended by the evacuation strategy. Issues such as reliability of fire safety systems and the potential for occupants not to respond to alarms are addressed by means of comparison with the reference building.

9.3.2 Background

Concealed spaces or cavities provide a path for smoke and flame spread. As fire and smoke spread could be concealed, the spread may go unnoticed for a considerable period causing deterioration of the structure and fire barriers prior to breaking out in a space often remote from the original ignition point. The extent of spread can be substantially accelerated if the lining materials and insulation within the void are combustible potentially causing multiple fire ignitions throughout a building unless mitigation measures are applied such as cavity barriers. Combustible services and structural elements may also facilitate spread but to a substantially lesser extent.

Examples of voids include roof spaces, ceiling cavities, wall cavities, sub floor spaces and platform floors.

The NCC *DTS Provisions* permit unprotected voids subject to limitations on size, combustibility of materials within the void and combustibility of the linings etc.

Cavity fires can present challenges to firefighters due to difficulties locating and accessing the fire. Difficulties in locating and accessing fires could result in delays to intervention and the need for large portions of a building to be evacuated.

9.3.3 Derivation of reference scenarios and performance criteria

During the Hazard ID process, any voids within the construction should be identified in the proposed *Performance Solution* and reference building together with any combustible materials that may form the boundaries of the void or be located within the void. Mitigation methods such as cavity barriers that are intended to be provided should also be identified.

If there are no voids in the proposed *Performance Solution*, no further analysis of this scenario is required.

If the extent of voids and combustible content and methods of protection are consistent with the reference building and comply with the NCC *DTS Provisions* and a qualitative / semi-quantitative review of the mitigation measures shows to the satisfaction of the PBDB stakeholders that fire spread via concealed spaces will not endanger occupants located in other rooms / spaces with all fire safety systems performing as intended. In this case no further analysis is required unless any of the proposed variations from the reference building for the proposed *Performance Solution* might increase the risk of fire or smoke spread through voids.

Validated models to evaluate fire spread through voids and cavities are very limited and reliance is commonly placed on reference or standard tests, fire incident data and technical publications or protection measures such as cavity barriers to limit the extent of spread such that structural adequacy and separating functions of barriers are maintained. Service penetration seals for services located in ducts, shafts and other cavities of the structure may also be used to manage spread through service ducts shafts and other voids.

A typical reference scenario would be the unreported ignition of material within a cavity caused by maintenance activities or an electrical fault that continues to spread undiscovered.

Typical performance criteria would be that the spread of fire and smoke via cavities would be no greater than that permitted by the NCC *DTS Provisions* and that occupants located in other rooms / spaces will not be endangered due to fire spread through cavities assuming all passive and active fire protection systems perform as intended by the design.

9.3.4 Typical mitigation measures

Typical mitigation methods include one or more of the following:

- (a) cavity barriers;
- (b) protection of service penetrations to restrict spread of fire to or from voids;
- (c) control of materials to limit fire and smoke spread / production;
- (d) sprinkler protection (if practicable) – obstructions by for example structural members may make this option impractical for smaller voids;
- (e) inclusion of automatic detection of heat or smoke within the concealed space.

9.4 Design scenario (SF): Smouldering fire

9.4.1 Intent

To determine, if the fire risk to occupants resulting from a smouldering fire in the proposed *Performance Solution* is less than or equal to the reference building.

9.4.2 Background

The SF scenario applies to occupancies that provide sleeping accommodation. Occupants who are asleep may not respond promptly to a fire that may not be of sufficient size to activate automatic detection and suppression systems such as smoke detectors, heat detectors and sprinkler systems.

9.4.3 Derivation of reference scenarios and performance criteria

During the Hazard ID process, areas where occupants may sleep should be identified along with adjacent areas where fires could occur that would generate sufficient smoke to present a hazard to the sleeping occupants.

One or more reference scenarios should be identified.

The performance criteria could be based on an ASET / RSET analysis although the results would tend to be sensitive to response time estimates for the occupants which vary substantially. To avoid subjectivity, and because a comparative analysis is required by the FSVM, it is reasonable to determine ASET and the time to detection and compare the differences in time for the proposed *Performance Solution* and the reference building.

When evaluating the consequences of smouldering fires exposure to carbon monoxide is generally the critical tenability criterion rather than exposure to heat or visibility. Therefore additional carbon monoxide tenability criteria should be defined during the PBDB process if fire modelling is required for the Smouldering Fire Scenario.

9.4.4 Typical mitigation measures

Generally for residential buildings smoke detection and alarm systems represent the only viable mitigation method, although a *Performance Solution* may consider variations from DTS compliant systems under certain circumstances, potentially in conjunction with other mitigation methods such as residential sprinklers.

9.5 Design scenario (HS): Horizontal fire spread

9.5.1 Intent

To determine if the risk of fire spread between buildings (or future buildings) is less than or equal to that for the reference building constructed in the same position and complying with the NCC *DTS Provisions*.

9.5.2 Background

The NCC contains *Verification Methods* CV1 and CV2 which are used to verify that CP2(a)(iii) has been satisfied with respect to fire spread between buildings. These have been adopted by the FSVM. Reference should be made to the NCC and Guide to Volume One for further information.

CV1 provide a means to verify whether or not a building minimises the risk of fire spreading between buildings on adjoining allotments. CV2 is essentially the same as CV1, except that it deals with the spread of fire between two buildings on the same allotment.

9.5.3 Derivation of reference scenarios and performance criteria

There are two reference fire scenarios addressed by CV1 and CV2.

Scenario 1: A fully developed fire in the proposed building exposes the external walls of a neighbouring building or the allotment boundary to an imposed heat flux.

Scenario 2: A fully developed fire on an adjoining allotment or another building or proposed building on the same allotment exposes the external walls of the proposed building to an imposed heat flux.

The following performance criteria are prescribed in CV1 and CV2:

- (a) A building must not cause heat flux in excess of the prescribed limits to be exceeded at the prescribed distances; and

- (b) A building must be capable of withstanding the prescribed heat fluxes based on the distances between buildings or boundaries.

9.5.4 Typical mitigation measures

Typical mitigation measures include:

- control of combustibility of external walls;
- separation distances;
- automatic fire sprinkler systems;
- specification of fire-resistant construction;
- restriction of opening sizes;
- protection of openings.

9.6 Design scenario (VS): Vertical fire spread

9.6.1 Intent

To determine, if the risk to life from a fire affecting the external wall including penetrations, cladding materials and attachments is less than or equal to that for the reference building constructed in accordance with the NCC *DTS Provisions*.

9.6.2 Background

The NCC contains Verification Method CV3 which is used to verify that the relevant parts of *Performance Requirement CP2* amongst other things have been satisfied with respect to minimising the risk to life from a fire affecting the external wall of a building. CV3 has been adopted by the FSVM. Reference should be made to the NCC, the Guide to Volume One and AS 5113:2016 including Amendment 1^[15] for further information.

Other fire safety measures are imposed in recognition that an external wall system tested to AS 5113 may contain combustible elements that still present a risk that needs to be mitigated further in order to minimise the risk of fire spread via the external wall of a building.

9.6.3 Derivation of reference scenarios and performance criteria

The nominated *design scenario* is that a fire source exposes the external wall of a building with the potential to ignite the external wall (if combustible) or cause spread between vertical openings presenting a risk to life as a consequence of fire spread, falling debris and spread to adjacent buildings.

A number of reference *design scenarios* can be derived based on the fire source. CV3 adopts an internal fully developed fire based on the fire sizes nominated in the test methods nominated by AS 5113 as a “reference source”.

CV3 also requires application of CV1 and CV2 (refer section 9.5).

9.6.4 Typical mitigation measures

Typical mitigation measures include:

- control of combustibility of external walls;
- distances between vertical openings;
- non-combustible and fire rated spandrels;
- horizontal projections from the façade;
- specification of fire-resistant construction;
- enhancements to automatic fire sprinkler systems;
- protection of openings;
- enhanced fire-resistant construction;
- enhances fire and smoke compartmentation within the building.

9.7 Design scenario (IS): Internal surfaces

9.7.1 Intent

To maintain tenable conditions to allow time for evacuation of occupants and to facilitate fire brigade intervention. To demonstrate that this intent has been achieved

it is required to show that the fire risk to occupants resulting from fire spread across internal surfaces is less than or equal to the reference building.

9.7.2 Background

Building contents are likely to be the first items ignited in most fires but materials forming internal surfaces can significantly affect the spread of fire and its rate of growth. Fire spread on internal surfaces in evacuation routes or accelerated spread of fire and smoke to evacuation routes is particularly important because occupants could be prevented from evacuating the building safely. Dowling^[16] found that fire spread beyond the room of origin was more likely with combustible wall and ceiling linings but data was insufficient to derive more specific information. Combustible interior finishes (surfaces) have been identified as a common contributing factor in a number of multi-fatality fires (e.g. Duval^[17] Fire Code Reform Centre Report PR98-02^[18]).

These findings are consistent with *Performance Requirement CP2* which states;

Performance Requirement CP2 Spread of fire

- (a) A building must have elements which will, to the degree necessary, avoid the spread of fire—
 - (i) to exits; and
 - (ii) to sole-occupancy units and public corridors; and

Application:

CP2(a)(ii) only applies to a Class 2 or 3 building or Class 4 part of a building.

- (iii) between buildings; and
 - (iv) in a building.
- (b) Avoidance of the spread of fire referred to in (a) must be appropriate to—
 - (i) the function or use of the building; and
 - (ii) the fire load; and
 - (iii) the potential fire intensity; and
 - (iv) the fire hazard; and
 - (v) the number of storeys in the building; and

- (vi) its proximity to other property; and
- (vii) any active fire safety systems installed in the building; and
- (viii) the size of any fire compartment; and
- (ix) fire brigade intervention; and
- (x) other elements they support; and
- (xi) the evacuation time.

9.7.3 Derivation of reference scenarios and performance criteria

During the Hazard ID process areas where internal surfaces vary from the NCC *DTS Provisions* should be identified together with their proximity to evacuation routes and occupied areas.

The FSVM does not include a qualitative description of a specific *Design Scenario* for internal surfaces which is due to the scenario varying with the orientation of the surface and in some cases the need for the effect of variations to internal linings to be integrated into other reference scenarios for scenarios BE, UT, CF RC, SS, FI and UF.

Example 1 Derivation of design scenario for wall and ceiling linings

When considering a *Performance Solution* involving wall and ceiling linings an appropriate design scenario could be a burning item igniting a wall lining potentially leading to the development of untenable conditions within the enclosure of fire origin and potentially flashover and a fully developed fire if there is no intervention.

When considering flooring and floor coverings the risk of accelerated fire spread is reduced due to the orientation of the materials. However, fire spread across combustible flooring could be accelerated prior to flashover due to radiant heat from a hot layer within and close to the enclosure of fire origin. A design scenario as detailed in Example 2 could be derived to address this.

Example 2 Derivation of design scenario for flooring and floor coverings

When considering a performance solution involving flooring and floor coverings an appropriate design scenario could be a growing fire subjecting the flooring to an increasing radiant heat flux potentially accelerating the development of untenable conditions within the enclosure of fire origin and potentially leading to flashover and a fully developed fire if there is no intervention.

Reference should be made to the following Fire Code Reform Centre publications for the technical background to the development of the DTS requirements for wall and ceiling linings and flooring / floor coverings which may inform the development of scenario clusters and reference scenarios for internal surfaces.

- Fire Performance of Wall and Ceiling Lining Materials Final Report - With Supplement^[18].
- Fire Performance of Floors and Floor Coverings^[19].

Variations to the reaction to fire performance of internal surfaces can be broken down into two categories:

Minor Performance Solutions - where the proposed materials do not significantly increase the rate of fire growth, smoke production and fire load within an enclosure and therefore the *Performance Solution* can be assessed in isolation without the need to consider other scenarios. Typical examples are:

Example 3 Performance Solution to permit the use of a fire-retardant coating to modify the performance of a wall lining

It would need to be demonstrated that the wall and ceiling linings for the proposed *Performance Solution* achieve the same or lower group number as the linings required for the DTS compliant reference building **and** that the required performance is expected to be maintained through the design life of the building with the proposed maintenance, management and inspection systems in place. Under these circumstances the equivalency of the proposed *Performance Solution* could be shown to be at least equivalent to that of the linings of the reference building.

Example 4 Combination lining system with Group 3 linings to walls up to a height of 1 m and Group 1 linings for walls above 1 m and the ceiling.

The reference DTS compliant building requires wall and ceiling linings that achieve Group 2 performance in accordance with Specification C1.10. In order to demonstrate equivalence a reference test was designed based on the ISO 9705^[20] full-scale room test method to simulate a fire in the subject enclosure. (Note the DTS requirements do not allow for tests on combinations of lining materials). The PBDB stakeholders indicated that the reference test would provide appropriate evidence of suitability if undertaken by an *Accredited Testing Laboratory* and the performance criteria of the combination lining systems (i.e. Group 3 up to a height of 1m and Group 1 above 1m) achieving the same level of performance (time to flashover) as required for the Group 2 classification and the nominated smoke production criteria are also satisfied.

General Performance Solutions – where the proposed materials significantly increase the rate of fire growth, smoke production or fire load adjustments may be required to scenarios BE, UT, CF RC, SS, FI and UF.

Example 5 Use of Group 3 linings instead of Group 2 linings

This *Performance Solutions* will potentially increase the growth rate reducing the time to flashover and time to untenable conditions within the enclosure of fire origin and adjacent enclosures and may also increase the fire load compared to the reference building. This will have the effect of modifying the reference design fires for scenarios BE, UT, CF RC, SS, FI and UF in the affected enclosures requiring detailed evaluation.

9.7.4 Typical mitigation measures

Typical mitigation methods include one or more of the following:

- enhancements to active fire protection systems (automatic fire sprinklers, detection and or smoke control) to address accelerated fire growth etc.;

- enhancements to fire and smoke compartmentation to address accelerated fire growth etc.;
- use of coatings or combinations of systems such that the hazard associated with internal surfaces is not increased.

9.8 Design scenario (FI): Fire brigade intervention

9.8.1 Intent

To intent of this design scenario is to:

- describe the fire event the fire brigade is expected to face at its estimated time of arrival,
- describe the scope and available fire-fighting facilities relative to the risk to building occupant safety and adjacent buildings,
- evaluate search and rescue activities as part of other scenarios relevant to the available fire-fighting activities,
- evaluate control and suppression activities as part of other scenarios relevant to the available fire-fighting activities, and
- evaluate the impact of building occupant evacuation on fire brigade intervention activities in cases where these are likely to occur simultaneously.

9.8.2 Background

Consideration of fire brigade intervention is not required if a building is located more than 50 km from the responding fire service. Under these circumstances the impact of fire brigade intervention should not be taken into account when evaluating the outcomes of any of the nominated scenarios. It is recommended that the PBDB specifically addresses the lack of fire brigade intervention and identifies if there is any need for additional compensatory measures as a result of the *Performance Solution*.

The fire brigade intervention scenario is normally integrated into other fire scenarios, particularly those that evaluate the performance of the overall building fire safety design and / or examine design robustness.

A specific fire brigade intervention scenario has been specified to ensure that matters relating to fire brigade personnel safety and provisions to facilitate fire-fighting and

search and rescue activities are addressed as part of the verification of the proposed *Performance Solution*.

Firefighters are equipped with protective equipment and a personal breathing apparatus that increases their resistance to heat and provides protection against toxic gas exposure. Specific tenability limits for firefighters from the FBIM manual^[21] are summarised in Section 10.5.2 .

Notwithstanding the higher tenability limits, the effectiveness of fire brigade search and rescue and fire control / suppression will be reduced under low visibility and elevated temperature conditions which must be accounted for in the FBIM analysis. The maximum safe period within a building for an individual in Breathing Apparatus (BA) is likely to be limited by the capacity of the BA tanks and this must also be accounted for.

To ensure that there is sufficient time for the fire brigade to complete search and rescue activities, untenable conditions for firefighters are to be evaluated within other appropriate scenarios as detailed below.

9.8.3 Derivation of reference scenarios and performance criteria

The applicable reference scenarios will be derived from the *design scenarios* listed in Table 9.2 as a minimum but additional *design scenarios* should also be included if they impact on fire brigade intervention.

The inter-relationships between fire brigade intervention and control /suppression of the fire and evacuation of occupants are shown in Figure 9.3.

Table 9.2 Performance criteria for relevant scenarios for fire brigade intervention

Comparative performance criteria	Scenario UF Unexpected catastrophic failure ¹	Scenario CF Challenging fire	Scenario RC Robustness check	Scenario SS Structural stability ²
Conditions at time of arrival	Comparison of risk of major structural collapse prior to or at time of arrival.	Comparison of fire size and time to FO compared to FB arrival time	Comparison of fire size and time to FO compared to FB arrival time	Comparison of risk of major structural collapse prior to or at time of arrival.
Outcome of search and rescue activities	Comparison of risk of major structural collapse prior to completion of Search and Rescue	Comparison of risk to occupants requiring assisted - evacuation	Comparison of risk to occupants requiring assisted - evacuation	Comparison of risk of structural collapse prior to completion of Search and Rescue
Outcome of control and suppression activities	Suppression and control activities included in scenario	Compare fire size and available water supplies at estimated time to water application.	Compare fire size and available water supplies at estimated time to water application.	Suppression and control activities included in scenario

Note 1 Unexpected Catastrophic failure is generally only applicable to buildings greater than three storeys high unless the PBDB determines the building to be of Importance Level 3 and 4 as defined in Table B1.2a of NCC Volume One.

Note 2 Only applicable to elements required by the NCC *DTS Provisions* or as part of the proposed *Performance Solution* to provide a level of resistance to fully developed or severe fires.

Figure 9.3 Stylised event tree derived from fire safety concepts tree - manage fire branch

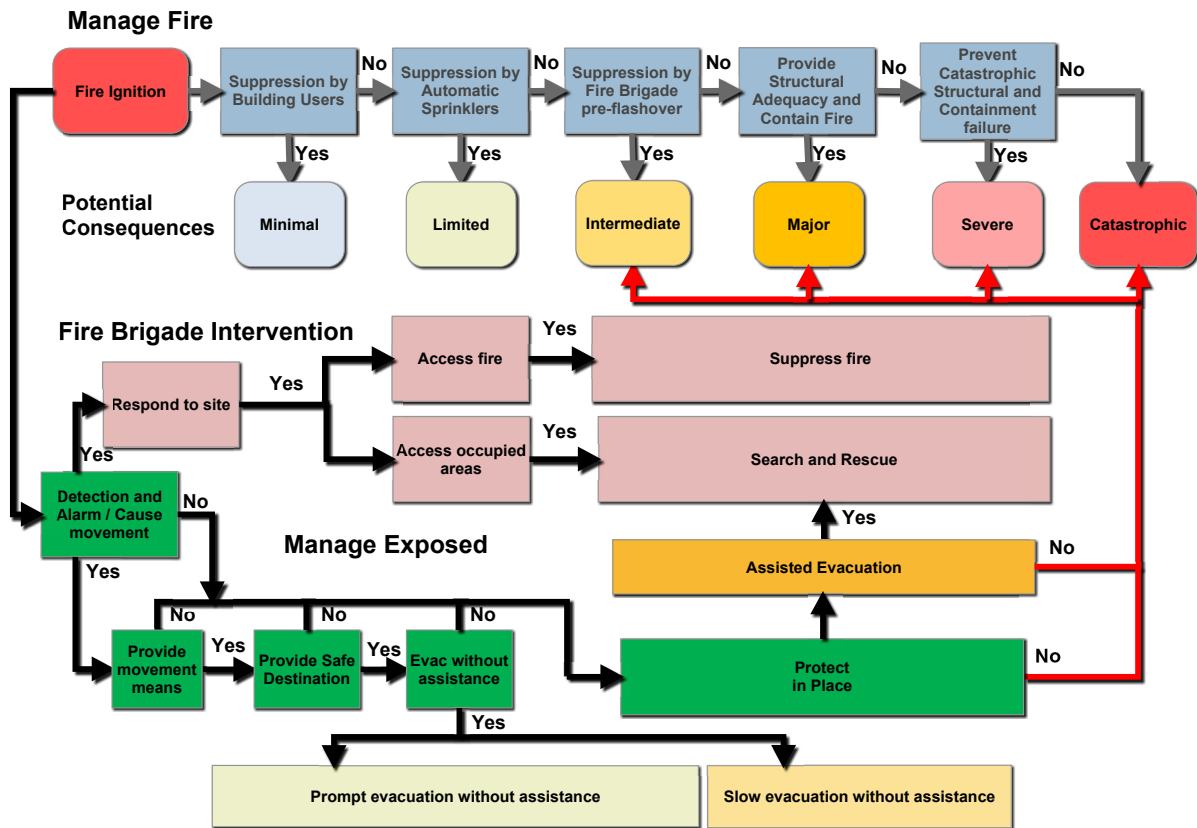

9.8.4 Typical mitigation measures

Typical Mitigation measures are summarised in Table 9.3.

Table 9.3 Typical measures required for fire brigade intervention

Facilities for fire brigade intervention	Building with sprinkler protection	Building without sprinkler protection
Fire brigade external access	Yes	Yes
Tenability to enable identification and access to seat of fire	Yes	Yes
Fire hydrants – internal required	Yes if > than 100 m to all points, and / or > 3 levels.	Yes if > than 70 m to all points, and / or > 3 levels.
Fire hydrants – external required	Yes	Yes
Command and control provisions	Yes, if > 3 levels	Yes

Facilities for fire brigade intervention	Building with sprinkler protection	Building without sprinkler protection
Access to normally occupied areas for search and rescue	Yes, if more than 50 persons occupy building.	Yes

Note: Additional measures may be required for buildings such as high-rise buildings which may present additional challenges for fire brigade intervention

9.9 Design scenario (UF): Unexpected catastrophic failure

9.9.1 Intent

The intent of the *design scenario* is to demonstrate that the building, its critical elements and the *fire safety system* provide sufficient robustness such that unexpected catastrophic failure is unlikely; To demonstrate that this intent has been achieved it is generally sufficient to show that the risk of disproportionate collapse due to fire is no greater than for the reference building constructed in accordance with the NCC *DTS Provisions*.

9.9.2 Background

Substantial protection to the structure from the impact of fully developed fires is required by the NCC *DTS Provisions* for buildings of Type A construction which are generally of medium-rise or high-rise buildings. These requirements are substantially relaxed for low-rise buildings of Type B and C construction and some low-rise buildings of Type A construction to which concessions apply. Therefore, the Unexpected Catastrophic failure scenario is generally only applicable to buildings greater than 3-storeys high unless the PBDB determines otherwise. This could be the case for low-rise buildings of Importance Level 3 and 4, for example as defined in Table B1.2a of NCC Volume 1 where the outcome of the PBDB process could be a requirement that Scenario UF be considered.

Application of the unexpected catastrophic failure (UF) scenario

Scenario UF is only applicable to buildings greater than 3-storeys high unless the PBDB determines the building to be of Importance Level 3 or 4 as defined in Table B1.2a of NCC Volume One, or otherwise presents a significant risk of unexpected catastrophic failure and it is necessary to apply Scenario UF.

The UF scenario is to be considered in coordination with the structural engineer in accordance with BP1.1(a)(iii) which are reproduced below:

BP1.1 Structural Reliability

(a) A building or structure, during construction and use, with appropriate degrees of reliability, must—

.....

- (iii) be designed to sustain local damage, with the structural system as a whole remaining stable and not being damaged to an extent disproportionate to the original local damage; and

BV2 Structural robustness

(3) Compliance with **BP1.1(a)(iii)** is verified for structural robustness by—

(a) assessment of the structure such that upon the notional removal in isolation of—

- (i) any supporting column; or
- (ii) any beam supporting one or more columns; or
- (iii) any segment of a load bearing wall of length equal to the height of the wall, the building remains stable and the resulting collapse does not extend further than the immediately adjacent storeys; and

(b) demonstrating that if a supporting structural component is relied upon to carry more than 25% of the total structure a systematic risk assessment of the building is undertaken and critical high-risk components are identified

and designed to cope with the identified hazard or protective measures chosen to minimise the risk.

Other than low-rise buildings where the potential for collapse is inferred to be acceptable by the NCC *DTS Provisions* as noted above it is expected that buildings will withstand the impact of a fire provided all fire safety systems perform in accordance with the design intent. This is represented by scenario CF.

However, Unexpected Catastrophic Failures can occur as the result of failures of one or more parts of the fire safety system. As this should be a very low probability event it is necessary to consider failures of multiple parts of the fire safety system. A generic progression to a catastrophic failure is shown in Figure 9.4

Figure 9.4 Progression to catastrophic collapse

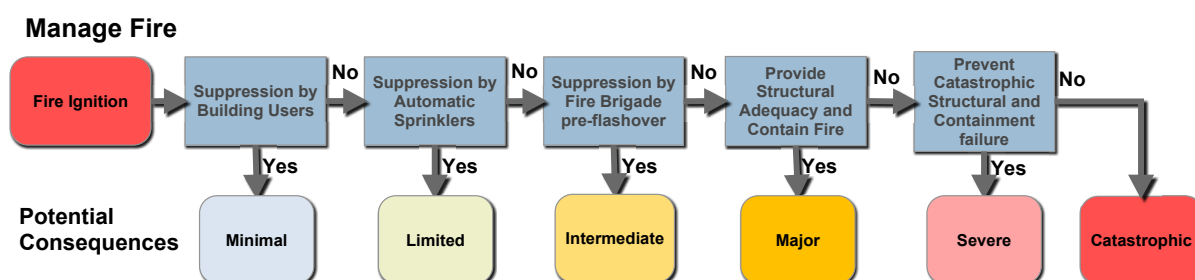

The earlier the progression is halted the less severe the consequences but for this scenario it is only necessary to determine the probability of collapse of the whole or a major part of the structure.

Suppression by users (occupants), automatic suppression systems or fire brigade intervention (as a result of a rapid response and relatively slow fire growth rates) prior to flashover in most circumstances will result in limited damage to the structure. The probability of a potential fully developed fire progressing to flashover can therefore be predicted by deriving the frequency of fires that occupants have been unable to manage from fire statistics, considering the reliability of automatic suppression systems if provided and undertaking an FBIM analysis and fire time line analysis to determine the probability of suppression prior to flashover (in some cases where there are no monitored detection systems, a conservative assumption can be made that the fire brigade arrive after flashover).

Determination of the scenario time (and probability) of structural failure is more complex.

Structural adequacy and containment are normally achieved through the specification of fire resistance/ protection systems and distributions can be derived to account for material property variations (structural elements and protection systems) uncertainty in relation to calculation methods to estimate the time to failure under the scenario heating regime(s) etc. However, the distribution requires further modification to also account for serious installation errors that can substantially reduce the performance of the system such as substitution of fire protective boards. Combining these distributions leads to a distribution with two peaks with the earliest occurring peak being the most critical for consideration of catastrophic failures.

Distributions can also be derived for design fire scenarios which account for enclosure sizes, ventilation conditions, thermal properties of enclosure boundaries and fire load. These distributions can be incorporated in multi-scenario analysis methods but may be simplified to a series of lumped times and probabilities depending on the selected analysis methods or a worst credible design fire.

For some larger enclosures due to the size and geometry of an enclosure and characteristics of the fire load a fully developed fire may be unlikely to occur in which case a design fire that provides the most significant threat to the structure should be derived.

The FBIM model can be used to estimate whether fire brigade intervention will occur and reduce the fire severity prior to failure of a structural element.

If failure of one or more elements occurs, it is then necessary to determine if it will lead to total or substantial collapse of the building. For buildings designed to Verification Method BV2, it is likely that failure of more than one element or segment will have to occur before “catastrophic collapse” results.

The structural engineer and fire engineer will need to work closely to evaluate the impact on the structure by the fire where the potential for collapse needs to be analysed. Structural performance should be checked by the structural engineer to

ensure no unexpected failure modes are likely. For individual structural elements this may mean that ductile failure modes are designed to ensure that premature brittle failure such as shear failure do not occur.

The selected methods of structural analysis should lead to reasonable consistency with the proposed stringency for normal structural design using *DTS Provisions* (i.e. fire protection systems evaluated under the standard fire resistance test AS 1530.4 and structural design to the relevant DTS structural codes with the design checked for resistance to disproportionate collapse).

For some very large buildings with large populations more detailed analysis of the risk of unexpected catastrophic failure may be considered appropriate by the PBDB stakeholders.

For high-rise buildings above an effective height of 60 m more extensive analysis of the structural behaviour at elevated temperatures may be appropriate to address the potential increase in societal risk associated with catastrophic collapse. The 60 m height was informed by the work of Kirby *et al* 2004 but depending on the structural form adopted an alternative threshold for requiring a more detailed analysis may be selected by the PBDB stakeholders.

9.9.3 Derivation of reference scenarios and performance criteria

Reference scenarios should be selected to provide a reasonable representation of the probability of catastrophic failure of a structure. This may require a series of reference scenarios with fires located in different positions. The selection of these scenarios will require close collaboration between the structural and fire engineers and in some cases the fire brigades.

Example:

In multi-storey buildings, fire brigade intervention will tend to be slower the higher the design fire location and the cross-sections of the element exposed to the fire are

likely to be smaller potentially causing earlier failure of structural elements but on the floors close to the top of the building failure of elements of construction may not initiate a catastrophic structural failure. A series of reference scenarios must therefore be selected on several levels of the building to provide a reasonable representation for analysis.

9.9.4 Typical mitigation measures

Typical mitigation methods include one or more of the following;

- provision of automatic sprinklers and or enhancements to the sprinkler system to enhance its reliability (to reduce the risk of serious fires occurring which could threaten the structure);
- provision of detection and alarm system with automatic notification of the fire brigade (to reduce the time to fire brigade intervention);
- increased fire resistance levels (the impact will depend on sensitivity of the risk to gross defects. i.e. if catastrophic collapse events are dominated by gross defects above a certain value the impact of increasing FRLs may be limited);
- adoption of procedures to reduce the risk from faulty installations, damage and deterioration of performance through the building life;
- increased structural redundancy and / or optimisation of design to address critical features identified during a detailed structural analysis;
- increased compartmentation to limit maximum fire size.

9.10 Design scenario (CF): Challenging fire

9.10.1 Intent

To determine, if the fire risk to occupants resulting from a challenging fire starting in a normally occupied space in the proposed *Performance Solution* is less than or equal to the reference building assuming all fire safety system perform in accordance with the design intent.

9.10.2 Background

The challenging fire is intended to represent a *design scenario* with the worst-credible fire in the normally occupied spaces throughout a building that are not addressed by other scenarios such as those listed below.

Challenging fires addressed in other scenarios

- Design scenario (BE) is the scenario applicable to fires close to evacuation routes
- Design scenario (UT) is the scenario applicable to fires occurring in normally unoccupied rooms
- Design scenario (RC) considers failure of fire protection systems to check the robustness of the proposed *Performance Solution*

For this *design scenario* it should be assumed that the building is fully occupied at the time of the fire and evacuation of all people must be addressed (i.e. consider prompt and slow unassisted evacuation and assisted evacuation as appropriate) for comparison with the risk to life for the reference building. Active and passive fire safety systems in the building are required to be assumed to perform as intended by the design.

Acceptable levels of safety

It is recognised that it is not practicable to totally remove the risk to life from building fires even when all fire safety systems within the building are fully operative. Under these circumstances loss of life is generally associated with the slow response time of occupants or blocked evacuation paths. Therefore, the method prescribed in the FSVM for determining compliance with the NCC is comparison with a reference building complying with the NCC *DTS Provisions* to reflect community expectations.

9.10.3 Derivation of reference scenarios and performance criteria

In some buildings, the locations of the challenging fires for the reference scenarios can be easily determined qualitatively, although sensitivity studies may be required in order to determine the precise location and nature of the reference challenging fire scenario that will produce the lowest ASET for a given escape route and / or space.

The number of reference scenarios to be proposed should reflect the size and complexity of the building as agreed with stakeholders during the PBDB stage of the project.

Design fires for each reference scenario should be modified as appropriate to account for factors such as the following:

- the fuel, type, quantity and fuel configuration;
- the enclosure characteristics and management systems in place;
- the impact of active and passive fire protection measures (e.g. automatic sprinkler intervention, smoke control systems); and
- general building ventilation systems.

The size and location of each challenging fire reference scenario should be determined with respect to the geometry, complexity, use and fire protection features in the building, the location of occupants and the escape routes. Therefore, it may be necessary to evaluate reference *design scenarios* in several locations because the worst-case location may not be readily apparent particularly where the fire location will have an impact on the fire plume and hence extent of air entrainment as described in Example 1 below.

Example 1 - Locating design fires in large enclosures

Design fire locations are to be selected for a large enclosure with over hanging projections with evacuation routes above floor level within the enclosure. A *Performance Solution* is preferred over compliance with Part G3 of NCC Volume One using the FSVM.

Reference scenarios with design fires in the following positions were required to be evaluated because the worst-credible fire could not be determined qualitatively.

- **In the centre of the atria** since sprinkler activation (if provided) would be expected to be the slowest and the plume temperatures relatively high, potentially compromising higher evacuation routes.
- **At various position under horizontal projections** where line plumes may form increasing the volume of smoke produced (although reducing concentrations of toxic species, particulates in the plume and the plume temperature). The larger smoke volumes may compromise a larger number of evacuation paths in less time.
- **In the corner of the atrium**, where there are no overhanging balconies where air entrainment will be constrained increasing plume temperatures and gas concentrations but reducing the plume volume.
- **Close to air inlets** where air flows may interact with the plume.

The following performance criteria apply for each reference scenario above:

- the risk to occupants for the proposed *Performance Solution* shall be less than or equal to the reference building assuming all fire safety system perform in accordance with the design intent.

9.10.4 Typical mitigation measures

This scenario relates to a general analysis of the fire safety plan for a building and mitigation methods will be derived on a case by case basis and enhanced if the analysis shows that the proposed building does not provide a level of safety at least equivalent to the reference building.

9.11 Design scenario (RC): Robustness check

9.11.1 Intent

To determine, if the failure of a critical part of the fire safety system occurs, the level of safety within the building will be at least equivalent to the *reference building* (assuming a comparable failure to the fire safety system in the *reference building*).

A supplementary ASET / RSET analysis is prescribed to check that occupants are provided with an opportunity to evacuate from floors or fire compartments other than the floor or compartment of fire origin if they respond promptly during the fire scenario and do not require assistance to evacuate.

9.11.2 Background

The robustness of a fire engineered solution may be described as a measure of the potential for a fire engineered solution not to fail.

Robustness is to be evaluated through the evaluation of scenarios in which a critical part of the building fire safety system fails whilst other fire safety measures that are not affected by the failure of the critical part perform in accordance with the design intent.

This robustness check is necessary because in many fire incidents failure of one or more fire safety measures have contributed to increasing the level of harm.

Probabilities of failure are typically derived from statistics, fault tree analyses or published literature although where data is limited a degree of judgement may be required. In these cases, obtaining a consensus during the PBDB process is important.

If a specific fire safety measure is identified as being a potential source of system failure, it may be necessary to introduce a compensating fire safety measure in order to minimise the potential for systemic failure. A determination of the need for a compensating measure is typically influenced by the probability of failure of individual measures and the consequences of failure.

Since both the probabilities of failure and consequences of failure vary considerably, if considered necessary, the robustness check may need to be expanded to address the simultaneous failure of more than one system where the probability of failure of a system is relatively high and / or the consequences of failure are relatively high.

Common mode failures

Common mode failures form a critical part of the robustness check and must be fully evaluated.

An example is provided below for a fire detection system which interacts with numerous other fire safety systems.

Example: Common mode failure analysis

The fire safety system design for a building relies on a fire detection system to raise an alarm, activate various smoke control systems, alert the fire brigade and release smoke doors with hold open devices.

The probability of a total failure of the detection system was estimated to be approximately 20%. It was determined that for this mode of failure no building alarm would be raised, the fire brigade would not be automatically alerted, the smoke control systems would not be activated and controlled appropriately, and the smoke doors would not 'fail safe' and close.

Prior to undertaking the detailed analysis, based on the above observations it was determined that because of the common mode failures the fire safety system was unlikely to be sufficiently robust and a review of the design was undertaken. In this instance it was decided to modify the proposed fire safety system to incorporate early automatic suppression of the fire in lieu of the active smoke control system, require smoke doors to be operated by local detectors independent of the main detection system and retain the fire detection system providing a more robust design for further analysis.

9.11.3 Derivation of reference scenarios and performance criteria

A systematic review of the building fire safety system should be undertaken (normally during the Hazard ID process) for the proposed *Performance Solution* and *reference building* identifying:

- the fire safety measures making up the building fire safety system,
- identifying modes of failure and the associated probabilities for each fire safety systems,
- identifying common mode failures,
- estimating if the likely consequences of the failure mode are significant.

Based on this preliminary analysis scenario clusters should be identified which are then converted to a one or more reference scenarios for each fire protection systems.

The reference scenarios represent expected failure modes that will have the most significant impact on the consequences of a fire and must include an evaluation of outcomes with common mode failures that have been identified and will affect other parts of the building fire safety system. The reference scenarios must reflect realistic failure modes and not be abstract constructs. For example, assuming a total failure of the detection system does not alert occupants but an automatic alarm to the fire brigade is activated by the detection system is not appropriate.

Consideration of fire brigade intervention

It is necessary to consider fire brigade intervention in an assessment of the robustness of a design since these are scenarios where fire brigade intervention is likely to be most critical and conditions that the fire brigade may face will be the most severe.

Typical performance criteria are:

- the risk to occupants for the proposed *Performance Solution* shall be less than or equal to the reference building assuming failure of similar fire safety systems in both buildings for each scenario; and

- ASET > RSET for the proposed *Performance Solution* to check that occupants in other compartments have the opportunity to evacuate if they respond promptly during the fire scenario and do not require assistance to evacuate.

9.11.4 Typical mitigation measures

Typical mitigation methods include:

- modification of fire protection system designs to improve reliability (e.g. provision of monitored sprinkler system control valves on each floor);
- reduction of common mode failures (e.g. use of independent fire detection systems for alarm and activation of smoke control measures);
- additional fire safety measures to improve robustness of the building fire safety system.

9.12 Design scenario (SS): Structural stability

9.12.1 Intent

The intent of the design scenario is to demonstrate that the building does not present an unacceptable risk to other property due to collapse or barrier failure resulting from a fire and demonstrate that the level of safety is at least equivalent to the *DTS Provisions*.

The current NCC *DTS Provisions* are deemed to provide an acceptable level of protection to other property and therefore the risk to other property for the proposed *Performance Solution* should be no greater than the *reference building* in addition to the level of safety for occupants being at least equivalent to the *DTS Provisions*.

9.12.2 Background

Substantial protection to the structure from the impact of fully developed fires is required by the NCC *DTS Provisions* for buildings of Type A construction which are generally medium-rise or high-rise buildings. These requirements are substantially relaxed for low-rise buildings of Type B and C construction and some low-rise Type A buildings to which concessions apply. The SS scenario only applies to applications

where fire resistance levels and / or fire protective coverings are specified within the NCC *DTS Provisions* as determined during the PBDB process and will therefore have limited applicability to Type B and C construction.

For Type A construction, it is expected that buildings will withstand the impact of a fire provided all fire safety system perform in accordance with the design intent. This is represented by scenario CF.

However, structural failures and fire barrier failures can result from failures of one or more parts of the fire safety system. As this should be a very low probability event but potentially high consequences it is necessary to consider failures of multiple parts of the fire safety system as required by the FSVM (including delayed fire brigade intervention). A generic progression to a failure of a structural element or barrier is shown in Figure 9.5.

Figure 9.5 Progression to failure of a structural element or barrier

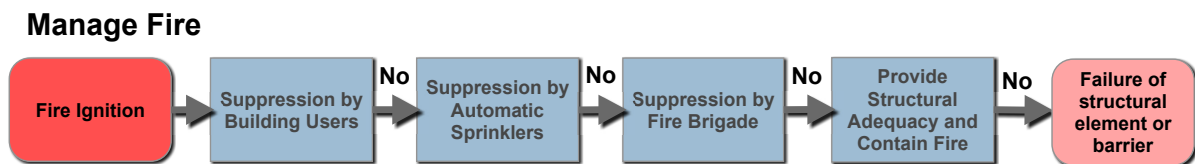

The earlier the progression is halted the less severe the consequences.

Suppression by users (occupants), automatic suppression systems or fire brigade intervention (as a result of a rapid response and relatively slow fire growth rates) prior to flashover in most circumstances will result in limited damage to the structure and barriers. The probability of a potential fully developed fire progressing to flashover can therefore be predicted by deriving the frequency of fires that occupants have been unable to manage from fire statistics, considering the reliability of automatic suppression systems if provided and undertaking an FBIM analysis and fire time line analysis to determine the probability of suppression prior to flashover.

Determination of the scenario time (and probability) of structural failure is more complex.

Structural adequacy and containment are normally achieved through the specification of fire resistance/ protection systems and distributions can be derived to account for

material property variations (structural elements and protection systems) and uncertainty in relation to calculation methods to estimate the time to failure under the scenario heating regime(s). However, this distribution requires modification to also account for serious installation errors that can substantially reduce the performance of the system such as substitution of fire protective boards. Combining these distributions leads to a distribution with two peaks with the earliest occurring peak being the most critical for consideration of structural and barrier failures.

Distributions can also be derived for design fire scenarios which account for enclosure sizes ventilation conditions, thermal properties, thermal properties of enclosure boundaries and fire load. These distributions can be incorporated in multi-scenario analysis methods but may be simplified to a series of lumped times and probabilities or a worst credible design fire depending on the selected analysis methods.

For some enclosures, due to the size and geometry of an enclosure and the characteristics of the fire load, a fully developed fire may be unlikely to occur. In which case, a non-flashover design fire that provides the most significant threat to the structure should be derived.

The FBIM model can be used to estimate whether fire brigade intervention will occur and reduce the fire severity to avoid failure of a structural element or barrier. If a distribution is not considered in the analysis a slow response from the fire brigade must be adopted which should be determined during the PBDB process (typically the 95th to 99th percentile of the time to application of water to the fire may be considered appropriate).

The failure time for an element of construction should be derived for or converted to the specific scenario time so that the risk to occupants and other property can be determined relative to the reference building.

9.12.3 Derivation of reference scenarios and performance criteria

Reference scenarios should be selected to provide a reasonable representation of the probability of failure of structural elements and barriers. This may require a series of reference scenarios with fires located in different positions and fires occurring in occupied and unoccupied areas should be considered.

Typical performance criteria are:

- The risk of failure of structural elements and barriers shall be less than or equal to the reference building assuming failure of similar fire safety systems in both buildings for each scenario.

9.12.4 Typical mitigation measures

Typical mitigation methods include one or more of the following:

- provision of automatic sprinklers and or enhancements to the sprinkler system to enhance its reliability (to reduce the risk of serious fires occurring which could threaten the structure);
- provision of detection and alarm system with automatic notification of the fire brigade (to reduce the time to fire brigade intervention);
- increased compartmentation to limit maximum fire size;
- increased fire resistance levels (the impact will depend on sensitivity of the risk to gross defects. (i.e. if catastrophic collapse events are dominated by gross defects above a certain value the impact of increasing FRLs may be limited)).

For high-rise buildings above an effective height of 60 m more extensive analysis of the structural behaviour at elevated temperatures may be appropriate to address the potential increase in societal risk. The 60 m height was informed by the work of Kirby *et al* 2004.

9.13 Additional scenarios

The 12 scenarios prescribed in the FSVM are likely to address the needs of many proposed *Performance Solutions* but do not address all potential *design scenarios*

that should be considered for every *Performance Solution* and part of the PBDB process is to identify if there is a need for consideration of other scenarios.

Typical examples include:

- exposure of structural elements to flames projecting from openings where a building has an external structural frame;
- dangerous goods;
- lift assisted evacuation which should include consideration of the requirements listed in DP7 in NCC Volume One.

Performance Requirement DP7

DP7 Evacuation lifts

Where a lift is intended to be used in addition to the required exits to assist occupants to evacuate a building safely, the type, number, location and fire-isolation must be appropriate to—

- (a) the travel distance to the lift; and
- (b) the number, mobility and other characteristics of occupants; and
- (c) the function or use of the building; and
- (d) the number of storeys connected by the lift; and
- (e) the fire safety system installed in the building; and
- (f) the waiting time, travel time and capacity of the lift; and
- (g) the reliability and availability of the lift; and
- (h) the emergency procedures for the building.

Further advice is available in ABCB Handbook - Lifts Used During Evacuation^[22] available from the ABCB website (abcb.gov.au).

The same principles outlined in the sections above should be applied in deriving reference scenarios for any additional *design scenarios* that are identified.

10 Analysis methods, inputs and criteria for comparison

10.1 General principles

The FSVM does not generally nominate specific methods of analysis other than requiring the proposed *Performance Solution* to be compared and be at least equivalent to a DTS compliant *reference building* that implicitly defines acceptable risk levels commensurate with public expectations.

This approach provides flexibility for the FSE to select methods that have acceptable accuracy (when used with appropriate data), efficiency and are suitable for the buildings being compared and relevant *design scenarios*.

The FSVM is required to be used by professional engineers competent in the field of fire engineering. They are expected to have the necessary expertise to select appropriate analysis methods and other evidence of suitability for the needs of a project and to satisfy the requirements of the FSVM with an independent review being provided by the *appropriate authority*. In some cases with the assistance of a peer reviewer in addition to other input from PBDB stakeholders such as the fire brigade. Each jurisdiction may from time to time restrict this role to specifically licenced or registered practitioners and users should consult with regulators to confirm if this is the case before using the FSVM.

General information on the selection of models and methods of analysis is provided below with more specific information on non-proprietary calculation methods and basic inputs provided in informative appendices published on ABCB website (abcb.gov.au).

The guidance in the following section provides an overview of some of the common analysis methods including verification and validation, but specific proprietary computer models are not nominated. For convenience the methods of analysis have been arbitrarily classified by the processes being modelled, but these may be integrated in some computer models / simulations.

The FSE should document in the PBDB report the basis for selection of models, calculation methods other evidence of suitability and related inputs.

10.2 Verification and validation of methods of analysis

Whichever methods are adopted a validation and verification review should be undertaken to ascertain if the proposed methods of analysis are appropriate. In many instances commonly used algebraic equations and computer models may have already been validated, particularly those that have been published in national or international standards or other recognised guides such as IFEG (2005) or by professional bodies such as Engineers Australia. Typical input data and some simple algebraic equations / calculation methods are also provided on the ABCB website (abcb.gov.au).

In these instances, the validation / verification review will need to check the method is being used within its field of application with appropriate inputs and is generally fit for purpose or provide a justification for use outside the field of application in the PBDB report and / or final fire engineering report.

ISO 16730-1^[23] describes procedures for validation and verification of models for general use. Simplified procedures may be accepted on a case by case basis where the specific application and sensitivity to results can be accounted for. For example, when undertaking comparative analyses, the outcomes may be less sensitive since the same variances will apply to the proposed design and *reference building*.

Robbins^[24] also provides general guidance on the validation of models for specific fire safety design applications.

10.3 Fire models

There are a large number of fire models available which can be broadly classified as algebraic equations / calculation methods or computer simulations used to quantify the spread of fire and products of combustion and determine the exposure of people, building elements and building contents. In the case of the FSVM the relevant targets are predominately people and adjacent properties, but other objectives may expand this to, for example, equipment required for business continuity.

Many algebraic equations relate to specific fire phenomena such as those listed in Table 10.1 together with references where further information may be obtained:

Table 10.1 Fire models and related reference materials

Phenomena	Typical reference material
Fire plumes	ISO 16734 ^[25]
Smoke layers	ISO 16735 ^[26]
Ceiling jet flows	ISO 16736 ^[27]
Vent flows	ISO 16737 ^[28]
Flashover	ISO 24678-6 ^[29]
Fully developed fires	Eurocode 1: Actions on structures —Part 1-2: General actions — Actions on structures exposed to fire ^[30] SFPE S.01:2011 Standard on Calculating Fire Exposures to Structures ^[31] – (also addresses local exposure in addition to enclosures)

Zone models and computational fluid dynamics (CFD) models address the above phenomena in a more holistic manner and are therefore in common usage. Guidance on the use of fire zone models is provided in ISO TS13447.^[32]

Examples of the verification and validation of zone and field models are provided in ISO/TR 16730-2:2013^[33] and ISO/TR 16730-3:2013^[34] respectively.

10.4 Evacuation and human behaviour models

Evacuation models can be either simple hand calculations or more advance simulation software. They can simply address the evacuation or integrate human behavioural aspects into a pre-movement phase and the evacuation phase and can account for congestion / the influence of smoke and other factors. Issues such as pre-movement times are best represented by stochastic distributions which may require simplification by creating clusters. It is important that the user has a clear understanding of the assumptions included in complex model and basis for the estimation of evacuation times. Further guidance is provided in ISO / TR 16738^[13] and ISO/ TR16730-5^[35] provides an example of the validation and verification of an evacuation model. ISO/TS 29761^[14] addresses the selection of design occupant behavioural scenarios.

10.5 Human exposure models

Human exposure models in their simplest form can be simple tenability limits but more complex models may include Fractional Effective Dose (FED), and Probit Functions amongst other things. Generally, for fire safety engineering applications in the built environment either simple tenability limits or FED models are adopted.

ISO 13571^[36] and ISO TR 13571-2^[37] provide guidelines for the estimation of the time to compromised tenability in fires and a methodology and examples of tenability assessments.

10.5.1 Occupant tenability criteria

For some *design scenarios* specified in the FSVM, the FSE must demonstrate that the occupants have sufficient time to evacuate the building before being overcome by the effects of fire (i.e. before being exposed to untenable conditions).

The FSVM has defined tenability criteria for typical occupants in terms of exposure to temperature / radiant heat and visibility as detailed below.

The following tenability criteria are to be determined at a height of 2 m above floor level:

- a FED of thermal effects greater than 0.3
- visibility is less than 10 m except-
in rooms of less than 100 m² or where the distance to an exit is 5 m or less, where visibility is permitted to fall to 5m.

The visibility criteria should be calculated assuming back lit exit signs unless determined otherwise during the PBDB process to address the specific design features of the proposed *Performance Solution* and / or reference building.

(Alternative visibility targets may be necessary if evaluating a *Performance Solution* that features alternatives to backlit exit signs, for example).

For smouldering fire scenarios a supplementary tenability criteria relating to exposure to carbon monoxide (CO) should be applied because experimental data has shown that for this type of design fire tenability based on carbon monoxide exposure is critical. The criteria should be agreed by the stakeholders during the PBDB process.

Rationalised tenability criteria for comparative analysis

Visibility will generally be the first tenability criterion exceeded prior to suppression.

Visibility and other species production rates such as CO and HCN are sensitive to materials involved in the fire and the combustion regime.

Visibility (and other species) can be correlated with the hot layer temperature rise and thus for some comparative analyses a practical approach is to derive temperature rise limits that can be applied in lieu of the visibility criteria.

Typical methods for the determination of the FED for thermal effects and deriving a correlation between temperature rise and visibility are provided in a data sheet from the ABCB website (abcb.gov.au). The derivation of a simple correlation for smoke layer temperature and visibility that may be suitable for some comparative analyses is also provided on the site which enables all tenability limits to be defined in terms of temperature.

General guidance for the estimation of times to compromised tenability in fires is also available in ISO 13571:2012^[36].

10.5.2 Firefighter tenability criteria

Guidance on tenability criteria for firefighters is provided in the AFAC FBIM Manual^[21].

The criteria assume firefighters are protected with full PPE and breathing apparatus and therefore exposure to toxic species is not generally relevant for most buildings. Whilst visibility is not a tenability criterion, reduced visibility will slow search and rescue and firefighting activities.

It should also be noted that the breathing apparatus capacity may limit the operating time under routine and hazardous conditions before the tenability criteria are exceeded.

Firefighter tenability criteria must be confirmed during the PBDB

The firefighter criteria listed below must be confirmed with the fire brigade representative of the PBDB team when discussing fire brigade intervention.

The following criteria, relative to height of 1500 mm above floor level, apply:

Routine Condition

Elevated temperatures, but not direct thermal radiation:

- Maximum time: 25 minutes
- Maximum air temperature: 100°C (in lower layer)
- Maximum radiation: 1 kW/m²

Hazardous Condition

Where firefighters would be expected to operate for a short period of time in high temperatures in combination with direct thermal radiation:

- Maximum time: 10 minutes
- Maximum air temperature: 120°C (in lower layer)
- Maximum radiation: 3 kW/m²

Extreme Condition

These conditions would be encountered in a snatch rescue situation or a retreat from a flashover:

- Maximum time: 1 minute
- Maximum air temperature: 160°C (in lower layer)
- Maximum air temperature: 280°C (in upper layer)
- Maximum radiation: 4 - 4.5 kW/m²

Critical Conditions

Firefighters would not be expected to operate in these conditions but could be encountered. Considered to be life threatening:

- Time: < 1 minute
- Air temperature: > 235°C (in lower layer)
- Radiation: > 10 kW/m²

FBIM Warning regarding occupant tenability

The following note is included in the FBIM manual:

“While firefighters can search under fire conditions which are untenable to building occupants, it is unlikely that the occupants will survive in this atmosphere, therefore these conditions are not satisfactory design criteria for occupant safety. Search and rescue cannot be undertaken in a compartment which has reached flashover, and it is not expected that occupants will survive in such an environment.”

10.6 Heat transfer models

Heat transfer models are commonly used to determine the temperature of barriers and structural elements when exposed to fire conditions and may be integrated with structural models in some circumstances. They can vary from simple empirical algebraic calculations that assumed a lumped thermal mass to finite element methods.

ISO/TR 16730-4:2013^[38] and SFPE S.02 2015^[39] provide details and examples of validation and verification of heat transfer models.

10.7 Structural models

Structural models are normally used in conjunction with heat transfer models to determine if structural failure is likely to occur and if so at what period into the fire scenario when failure is likely to occur. The complexity can vary considerably from simple correlations based on a relationship between load capacity and the temperature of a lumped thermal mass for a single element to finite element analyses considering variations in material properties with temperature in 2 or 3 dimensions for the whole structure or substantial parts of the structure. In many cases the structural and heat transfer models may be integrated.

A survey of international approaches to the structural design for fire was undertaken by Duthinh^[40] and provides useful resource.

An example of validation and verification of a combined structural and heat transfer model is provided in ISO/TR 16730-5:2013^[35].

More general advice on the design of structures for fire is provided in ISO/TS 24679^[41].

10.8 Application of data from test methods surveys and technical literature

Data from test methods or experiments / surveys are often available in the form of technical reports or published in technical journals. This type of data is often used in support of a method of analysis. The data should be checked to ensure that it is appropriate for the intended application with respect to repeatability, reproducibility and accuracy and these checks should be documented in the PBDR.

Some matters for consideration when undertaking this task could be:

- Was a test performed by an appropriately accredited laboratory and undertaken to a recognised standard or documented test method with clear performance criteria?
- Is the data comparable to similar data from other sources and if not, can the differences be explained?
- Is the data directly applicable or does it need adjustment? If so, details of adjustments and justification should be documented.

10.9 Application of data from reference tests

If calculation methods are not available or the validity is not able to be demonstrated to the satisfaction of the stakeholders, evidence of suitability may be obtained from a reference test directly or in combination with calculations / modelling and engineering judgement. Where practicable the test should be full-scale. The test(s) should be designed to reproduce all important features of fire behaviour for the situation of interest. The basis of the test design and required performance criteria should be documented prior to test and agreed with relevant stakeholders.

Reference tests may be undertaken in some circumstances using standard test equipment and methods; for example, the use of the ISO 9705 room burn facility for evaluation of linings or in other cases non-furnace based large scale simulations may be undertaken.

Useful guidance is available in the following publications:

ISO/TR 17252:2008 Applicability of reaction to fire tests to fire modelling and fire safety engineering^[42]

ISO/TR 15658:2009 — Fire resistance tests — Guidelines for the design and conduct of non-furnace-based large-scale tests and simulation^[43]

10.10 Criteria for evaluation of scenarios

Comparative performance criteria to compare designs will need to be derived for each of the scenarios required to be evaluated and more specific guidance is provided in Section 9. However, tenability limits for occupants and firefighters are common to many scenarios and general guidance is provided in Section 10.5 based on the content of the FSVM.

Confirmation of comparative performance criteria

Comparative performance criteria often require minor adjustments to be compatible with the selected evaluation methods and features of the *Performance Solutions* being compared. The performance criteria must be documented and agreed during the PBDB process at the same time the evaluation methods (analysis methods) are agreed.

The FSVM requires comparative analysis of the *Performance Solution* against a reference building which is expected to reduce the sensitivity to inputs and methods of analysis particularly if sensitivity analyses are undertaken to show that the ranking of the buildings does not change for the likely range of input values.

11 Performance-based design brief (PBDB) report

At the end of the PBDB process before undertaking the detailed analysis the PBDB report will normally be prepared by the FSE based on the deliberations of the PBDB stakeholders.

A typical PBDB report should include the following:

- Executive summary
- Scope of the project
- Details of the constitution of the PBDB including members representing the interests of stakeholders that cannot be represented
- Principal building characteristics
- Occupant profile and characteristics
- General objectives
- Basis for the development of a fire safety strategy as defined in Section 5.7.
- Fire safety strategy documentation
- Basis for the selection of the assessment method (FSVM)
- Derivation and characterisation of the reference building
- Hazard identification process including:
 - Identification of variations from the DTS reference building and relevant *Performance Requirements*
 - Identification of scenarios required by FSVM for consideration
- Detailed hazard identification to:
 - derive the location and other parameters for the FSVM prescribed scenarios
 - fully justify setting aside fire scenarios prescribed by the FSVM if they are not considered relevant to *Performance Solution* under consideration
 - explain the basis for adding additional scenarios and the derivation of the detailed scenario specification
 - derive reference scenarios from the *design scenarios*
- Analysis methods, key inputs and criteria for comparison with the reference building including justification for variations from base values for inputs provided in the Appendices associated with this Handbook

- Standards of construction, commissioning, management, use and maintenance and identification of responsibilities
- Details of any dissenting views from the PBDB and efforts to resolve them
- Conclusions

The description of the fire safety strategy within the PBDB report must include details of the evacuation and / or defend in place strategies applicable to all people and the management regimes necessary to ensure that the fire safety strategy will remain effective through the building life cycle.

12 Performance-based design risk assessment

12.1 Overview of performance-based design risk assessment

To compare the proposed *Performance Solution* with the reference building, it may be necessary to perform a risk assessment rather than only rely on a deterministic analysis. If the reliability of the fire safety systems vary appreciably between the proposed *Performance Solution* and reference building a risk assessment will generally be required.

The reason for this is best demonstrated by the following simple example comparing two systems.

Example: Comparing similar fire safety systems with different reliabilities

For both systems:

If they operate in accordance with the design intent, based on deterministic modelling no occupants are expected to be exposed to untenable conditions.

If they fail to operate in accordance with the design intent, based on deterministic modelling there are expected to be 2 people exposed to untenable conditions.

- System A (the reference solution) has an estimated reliability of 90% (10% probability of failure)
- System B (the proposed *Performance Solution*) has an estimated reliability of 70% (30% probability of failure)

Relying on the deterministic analysis it would be concluded that Systems A and B are equivalent.

If a risk assessment is undertaken adding a frequency or probability analysis to the results of the deterministic analysis, the probabilities of exposure to untenable conditions for each of the systems would be:

System A ... $0.1 \times 2 = 0.2$ and,

System B ... $0.3 \times 2 = 0.6$

System B, would expose occupants to a risk 3 times greater than the reference solution and the systems cannot be considered to have equivalent safety levels.

The most comprehensive method of undertaking the comparative analysis would be to undertake a detailed quantitative risk assessment (QRA) but due to the complex time dependent interactions between the fire, fire safety systems and occupants / fire services such an approach often requires substantial resources and reliance on methods such as multi-scenario analysis.

However, for many *Performance Solutions* particularly those that have relatively minor differences from the reference building it is possible to consider simple event tree analyses for the frequency / probability component of the risk assessment and a deterministic analysis for the consequence component of selected scenarios. An overview of a simple risk assessment process is shown in Figure 12.1.

Figure 12.1 Flow chart showing the risk assessment component of the analysis

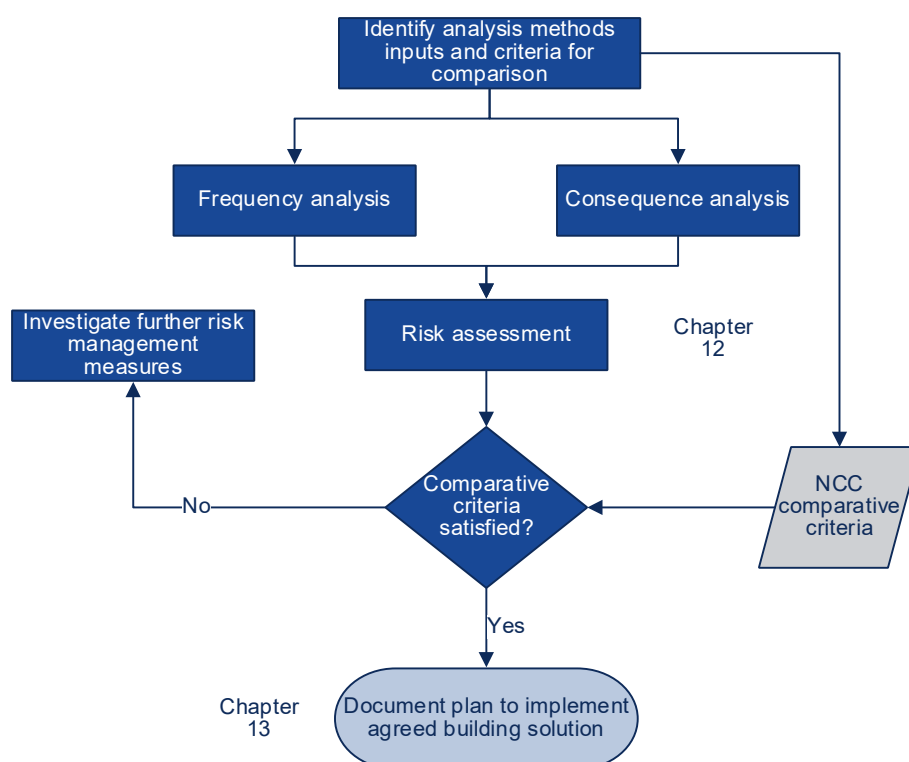

12.2 Frequency analysis

The extent of frequency analysis required will depend upon the *design scenarios* being considered and extent of differences from the reference building. Whilst some scenarios such as the Robustness Check and Unexpected Catastrophic Failure have obvious frequency analysis components, simple frequency analysis should also be included for all scenarios to show that the ranking of the reference and *Performance Solutions* based on deterministic (consequence analysis) is unlikely to change, if issues such as system reliability are considered.

An overview of the potential interactions between various components (or sub-systems) of the fire safety strategy for a building is provided in Figure 12.2 which has been derived from the manage fire impact branch of the NFPA fire safety concepts tree^[44] with additional fire brigade intervention content. It can be viewed as a partial stylised event tree, but it should be noted that detailed event trees could be constructed for many of the actions in a single cell and most outcomes will depend on the relative timing of the actions.

Figure 12.2 Stylised event tree derived from fire safety concepts tree manage fire branch

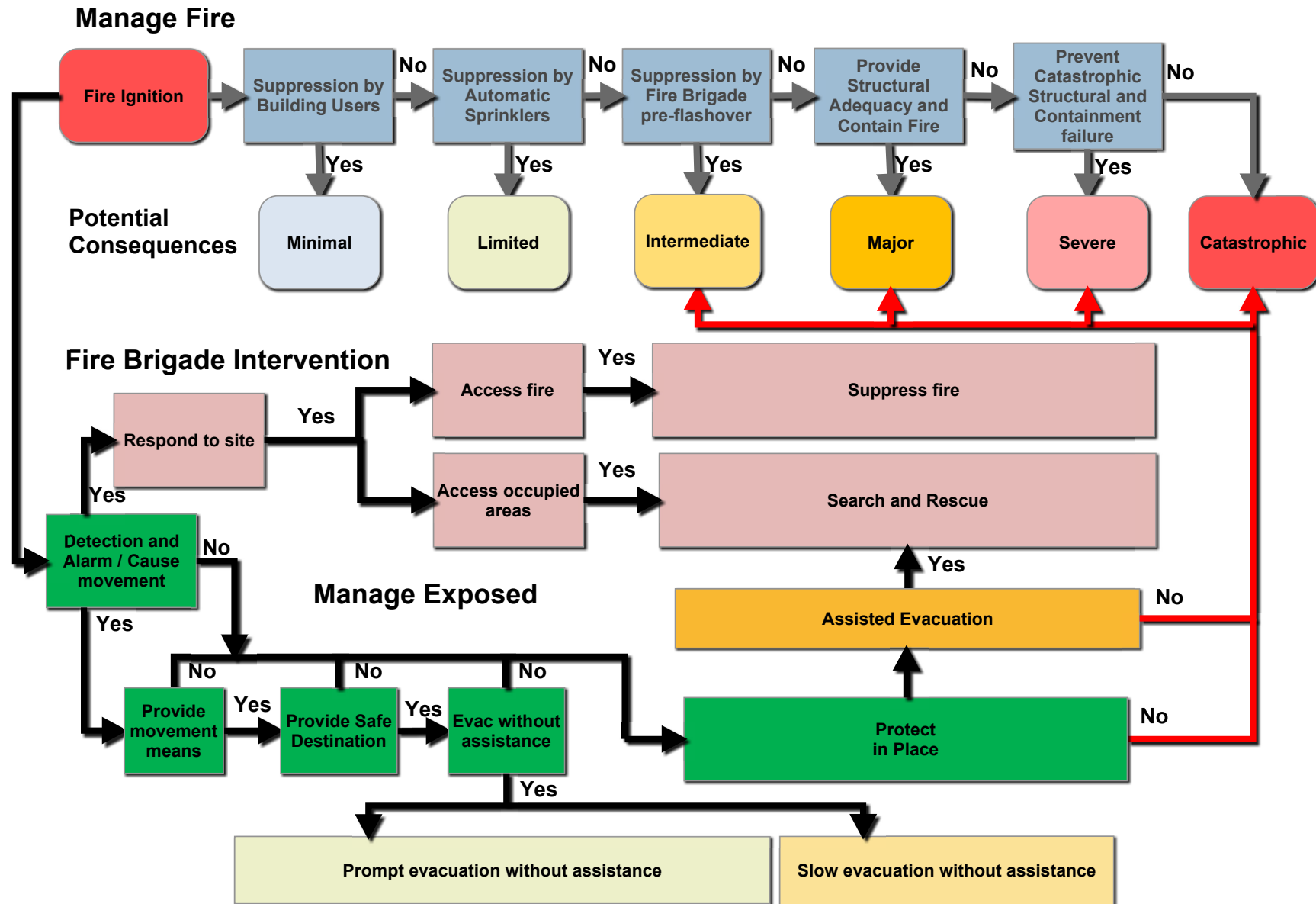

When undertaking frequency analysis, it is important to identify interrelationships between component parts of a fire safety strategy.

From Figure 12.2, it can be observed that there are a number of interventions that can occur to prevent collapse of a building and if any one of these is successful collapse will be prevented.

Conversely, Figure 12.2 shows that in order for an occupant to evacuate a building:

- detection and alarm need to occur AND
- cause the occupant to move AND
- provision needs to be made for movement means (i.e. provide capacity, route completeness, protected paths, and route access) AND
- a safe destination needs to be provided AND
- the person needs to be able to evacuate without assistance.

If any one of these conditions is not satisfied evacuation without assistance will not be successful and reliance will be placed on fire brigade search and rescue activities.

It should also be noted that failure of a detection and alarm system will not only impact on evacuation, it may also delay the call out of the fire brigade and fail to activate active smoke control measures linked to the detection system.

It is therefore important to consider these modes of failures particularly if there are significant differences in the fire protection approaches adopted for the reference building and proposed *Performance Solution*.

12.3 Consequence analysis

The consequence analysis will generally focus on exposure of occupants to untenable conditions or other criteria nominated for the scenario under consideration.

Specific analysis methods have generally not been specified in the FSVM to avoid restricting innovation, indirectly imposing specific solutions, and to allow the fire safety engineer, subject to agreement through the PBDB process, to apply appropriate methods.

Some generalised methods have been referenced in the FSVM such as ASET / RSET analysis for example.

The variability of human behaviour and differing response capabilities mean that the RSET is a stochastic distribution as identified by Babrauskas^[12]. This is taken account of in Figure 12.2 by categorising the evacuation timing and capabilities as:

- prompt evacuation without assistance;
- slow evacuation without assistance;
- assisted evacuation.

The assisted evacuation group includes people that have not been able to respond and evacuate the building, re-entered the building or are unable to evacuate the building because paths of travel to exit or exits are compromised. This group is reliant on fire brigade search and rescue activities to complete the building evacuation.

Babrauskas^[12] identified an alternative approach to ASET / RSET that can be employed for comparative analyses where there are no changes to the evacuation paths, number and profile of occupants etc. (i.e. the RSET distribution would be the same for both buildings). Under such circumstances for a comparative analysis, subject to agreement by the PBDB ASET values may simply be compared. This is justified on the basis that if it is reasonable to assume a similar distribution for the proposed *Performance Solution* and reference buildings the greater value of ASET the greater will be the level of safety (or the lower the fire risk).

For the following scenarios additional criteria are nominated as detailed below which are addressed further in the respective scenario specific sections in Chapter 9.

Scenario RC – Robustness check - disproportionate spread of fire does not occur.

Scenario SS – Structural stability – collapse or barrier failure due to fire.

Scenario HS - Horizontal spread - fire will not spread to and from adjacent buildings.

Scenario VS – Vertical spread - excessive vertical fire spread.

Scenario UF – Unexpected catastrophic failure - demonstrate that the building, its critical elements and the *fire safety system* provide sufficient robustness such that unexpected catastrophic failure is unlikely.

12.4 Comparison with the reference building

The FSVM generally requires that it is demonstrated that the level of safety be at least equivalent to the *DTS Provisions* subject to verification of the suitability of DTS benchmarks as set out in clause 1.3.1.3 of the FSVM.

This can be restated as follows to provide further clarity;

For each of the nominated scenarios it is demonstrated that the level of safety achieved by the proposed *Performance Solution* is at least equivalent to the selected reference DTS compliant building or rephrased in terms of risk as;

For each of the nominated scenarios it is demonstrated that the risk to life or risk of other adverse outcome prescribed for the scenario is no greater for the proposed *Performance Solution* than the selected reference DTS compliant building.

As noted above the most comprehensive method of undertaking the comparative analysis would be to undertake a detailed QRA using methods such as multi scenario analysis.

But where appropriate it is reasonable (and conservative) to adopt a simple event tree analysis (or fault tree analysis) for the frequency / probability component and use deterministic (consequence) analysis to determine the outcomes for critical branches.

13 Performance-based design report (PBDR)

Once the analysis of all relevant *design scenarios* for all the required *Performance Solutions* has been completed, the FSE must prepare a final PBDR that includes the following:

- The agreed PBDB and fire safety strategy reports and documentation - updated if necessary (refer Sections 5.7 and 11), This should include the provision of a fire safety handbook detailing the fire strategy and requirements for implementation and management of the fire safety strategy throughout the building life, incorporate critical matters such as evacuation strategies for all occupants and procedures necessary to achieve the required reliability from fire protection systems;
- A statement that the FSVM has been adopted;
- If additional scenarios have been identified, a description of the additional scenarios analysed;
- For each scenario all modelling and analysis results and comparison against the *reference building* results to demonstrate that the proposed building provides a level of safety at least equivalent to the relevant NCC Volume One *DTS Provisions*;
- Any other information required to clearly demonstrate that the building and its fire safety system satisfies the relevant NCC *Performance Requirements*.
- A separate NCC assessment summary section that includes:
 - A listing of all variations from the *DTS Provisions*;
 - A listing of all the *Performance Requirements* affected by the variations;
 - A summary of all prescribed scenarios requiring analysis together with a clear statement as to whether the fire safety level achieved by the proposed *Performance Solution* was at least equivalent to the reference DTS compliant building.
 - A summary of any additional scenarios analysed together with a clear statement as to whether the fire safety level achieved by the proposed *Performance Solution* was at least equivalent to the reference DTS compliant building
- If the proposed *Performance Solution* achieves a fire safety level for all scenarios that is at least equivalent to the reference DTS compliant building and the FSVM has been applied a statement that:
 - The NCC *Fire Safety Verification Method* has been applied and the *Performance Solution* described in this report and the following referenced

documentation has been shown to satisfy the relevant NCC *Performance Requirements* on the basis that the level of fire safety is at least equivalent to the reference DTS compliant reference building.

- Ref 1 (e.g. detailed design drawings)
- Ref 2 (fire safety handbook)
- Any variation of the *Performance Solution* from that described in this report may invalidate this conclusion.
- The name, qualifications and relevant registration details of the professional fire engineer(s) preparing the report
- Peer reviewer's signed statement (if used) on the overall report.
- Date of issue.

14 References

1. ABCB, National Construction Code 2019 -. 2019.
2. Verification Method C/VM2: Framework for Fire Safety Design for New Zealand Building Code Clauses C1-C6 Protection from Fire. 2014, Ministry of Business Innovation and Employment NZ.
3. National_Fire_Protection_Association, NFPA 5000: Building construction and safety code. 2018: The Association.
4. ISO, ISO 16733-1 2015 Fire Safety Engineering-Selection of design fire scenarios and design fires: Part 1 Selection of Design fire scenarios. 2015, ISO/TS 16733-2015: Switzerland.
5. ABCB, International Fire Engineering Guidelines Edition 2005. 2005, Australian Building Codes Board: Canberra.
6. ISO, ISO 23932-1 Fire safety engineering - General principles Part 1 General. 2018, ISO: Switzerland.
7. ABCB, Guide to NCC Volume One 2019. 2019, Australian Building Codes Board: Canberra.
8. Beck, V., Fire research lecture 1993: performance based fire safety design—recent developments in Australia. Fire safety journal, 1994. **23**(2): p. 133-158.
9. ABCB, Building Code of Australia 1996. 1996, ABCB: Canberra.
10. Safe_Work_Australia, Safe Design of Structures - Code of Practice 2012, Safe Work Australia.
11. Department_of_Human_Services. Capital Development Guidelines — Fire Safety Handbook. 2013 [cited 2018 12 October 2018]; Fire safety Handbook Template]. Available from: <https://providers.dhhs.vic.gov.au/sites/dhhsproviders/files/2017-07/Fire-Safety-Handbook-Template.pdf>.
12. Babrauskas, V., J.M. Fleming, and B. Don Russell, RSET/ASET, a flawed concept for fire safety assessment. Fire and Materials, 2010. **34**(7): p. 341-355.
13. ISO, ISO /TR 16738:2009 Fire Safety Engineering - Technical information on methods for evaluating behaviour and movement of people. 2009, ISO: Switzerland.

14. ISO, ISO/TS 29761:2015 — Fire safety engineering — Selection of design occupant behavioural scenarios. 2015, ISO: Switzerland.
15. Standards_Australia, AS 5113:2016 incorporating Amendment 1 Classification of External walls of buildings based on reaction-to-fire performance. 2016, Standards Australia: Sydney.
16. Dowling, V.P. and G.C. Ramsay, Building Fire Scenarios - An Analysis of Fire Incident Statistics. 1996, CSIRO: Australia.
17. Duval, R.F., NFPA Case Study: nightclub fires. 2006: National Fire Protection Association, Fire Investigations Department.
18. FCRC, Fire Performance of Wall and Ceiling Lining Materials Final Report - With Supplement, in FCRC Project 2 - Stage A Fire Performance of Materials. 1998, FCRC: Sydney.
19. FCRC, Fire Performance of Floors and Floor Coverings, in FCRC Project 2 - Stage B Fire Performance of Materials. 1999, FCRC: Sydney.
20. ISO, ISO 9705 Fire tests - Full-scale room test for - surface products. 1993, International Standards Organisation: Geneva.
21. Australasian_Fire_Authorities_Council, Fire Brigade Intervention Model v2.2,. 2004, Australasian Fire Authorities Council Australia.
22. ABCB, Handbook - Lifts Used During Evacuation. 2013, Australian Government and States and Territories of Australia: Canberra.
23. ISO, ISO 16730-1 2015 — Fire safety engineering — Procedures and requirements for verification and validation of calculation methods — Part 1 General. 2015, ISO: Switzerland.
24. Robbins, A. and C. Wade, Guidance for Validation of Models for Specific Fire Safety Design Applications, in Study Report. 2013, BRANZ: New Zealand.
25. ISO, ISO 16734 Fire Safety Engineering - Requirements governing algebraic equations - Fire Plumes. 2006, ISO: Switzerland.
26. ISO, ISO 16735 2006 Fire Safety Engineering - Requirements governing algebraic equations - Smoke layers. 2006, ISO: Switzerland.
27. ISO, ISO 16736 2006 Fire Safety Engineering - Requirements governing algebraic equations - Ceiling Jet Flows. 2006, ISO: Switzerland.

28. ISO, ISO 16737 2012 Fire Safety Engineering - Requirements governing algebraic equations - Vent flows. 2012, ISO: Switzerland.
29. ISO, ISO 24678-6 2016 — Fire safety engineering — Requirements governing algebraic formulae — Part 6 Flashover related phenomena. 2016, ISO: Switzerland.
30. British_Standards_Institution, Eurocode 1: Actions on structures —Part 1-2: General actions — Actions on structures exposed to fire. 2002.
31. SFPE, SFPE S.01 (2011) SFPE Engineering standard on calculating fire exposures to structures,. 2011, SFPE: Bethesda, MD.
32. ISO, ISO/TS 13447:2013 — Fire safety engineering — Guidance for use of fire zone models. 2013, ISO: Switzerland.
33. ISO, ISO/TR 16730-2:2013 — Fire safety engineering — Assessment, verification and validation of calculation methods — Part 2: Example of a fire zone model. 2013, ISO: Switzerland.
34. ISO, ISO/TR 16730-3:2013 — Fire safety engineering — Assessment, verification and validation of calculation methods — Part 3: Example of a CFD model. 2013, ISO: Switzerland.
35. ISO, ISO/TR 16730-5:2013 — Fire safety engineering — Assessment, verification and validation of calculation methods — Part 5: Example of an Egress model. 2013, ISO: Switzerland.
36. ISO, ISO 13571:2012 — Life-threatening components of fire — Guidelines for the estimation of time to compromised tenability in fire. 2012, ISO: Switzerland.
37. ISO, ISO/TR 13571-2:2016 — Life-threatening components of fire — Part 2: Methodology and examples of tenability assessment. 2016, ISO: Switzerland.
38. ISO, ISO/TR 16730-4:2013 — Fire safety engineering — Assessment, verification and validation of calculation methods — Part 4: Example of a structural model. 2013, ISO: Switzerland.
39. SFPE, SFPE S.02 (2015) SFPE Engineering standard on Calculation Methods to predict the Thermal Performance of Structural and Fire Resistive Assemblies. 2015, SFPE: Bethesda, MD.
40. Duthinh, D. and D. Duthinh, Structural design for fire: A survey of building codes and standards. 2014: US Department of Commerce, National Institute of Standards and Technology.

41. ISO, ISO TS 24679 2011 — Fire safety engineering — Performance of structures in fire. 2011, ISO: Switzerland.
42. ISO, ISO/TR 17252:2008 — Fire tests — Applicability of reaction to fire tests to fire modelling and fire safety engineering. 2008, ISO: Switzerland.
43. ISO, ISO/TR 15658:2009 — Fire resistance tests — Guidelines for the design and conduct of non-furnace-based large-scale tests and simulation. 2009, ISO: Switzerland.
44. National_Fire_Protection_Association, NFPA 550: Guide to the Fire Safety Concepts Tree. 2012, National Fire Protection Association: Quincy, MA.
45. AUBRCC, Building Code of Australia 1988. 1988, AUBRCC: Canberra.
46. AUBRCC, Building Code of Australia 1990. 1990, AUBRCC: Canberra.
47. ABCB, Building Code of Australia 2004 Volume 1. 2004, ABCB: Canberra.
48. Kirby, BR 2004. A new approach to specifying fire resistance periods. The Structural Engineer - 5 October 2004.

APPENDICES



Appendix A Compliance with the NCC

A.1 Responsibilities for regulation of building and plumbing in Australia

Under the Australian Constitution, State and Territory governments are responsible for regulation of building, plumbing and development / planning in their respective State or Territory.

The NCC is an initiative of the Council of Australian Governments (COAG) and is produced and maintained by the ABCB on behalf of the Australian Government and each State and Territory government. The NCC provides a uniform set of technical provisions for the design and construction of buildings and other structures, and plumbing and drainage systems throughout Australia. It allows for variations in climate and geological or geographic conditions.

The NCC is given legal effect by building and plumbing regulatory legislation in each State and Territory. This legislation consists of an Act of Parliament and subordinate legislation (e.g. Building Regulations) which empowers the regulation of certain aspects of buildings and structures, and contains the administrative provisions necessary to give effect to the legislation.

Each State's and Territory's legislation adopts the NCC subject to the variation or deletion of some of its provisions, or the addition of extra provisions. These variations, deletions and additions are generally signposted within the relevant section of the NCC, and located within appendices to the NCC. Notwithstanding this, any provision of the NCC may be overridden by, or subject to, State or Territory legislation. The NCC must therefore be read in conjunction with that legislation.

A.2 Demonstrating compliance with the NCC

Compliance with the NCC is achieved by complying with the Governing Requirements of the NCC and relevant Performance Requirements.

The Governing Requirements are a set of governing rules outlining how the NCC must be used and the process that must be followed.

The Performance Requirements prescribe the minimum necessary requirements for buildings, building elements, and plumbing and drainage systems. They must be met to demonstrate compliance with the NCC.

Three options are available to demonstrate compliance with the Performance Requirements:

- a Performance Solution,
- a DTS Solution, or
- a combination of a Performance Solution and a DTS Solution.

All compliance options must be assessed using one or a combination of the following Assessment Methods, as appropriate:

- Evidence of Suitability
- Expert Judgement
- Verification Methods
- Comparison with *DTS Provisions*.

A figure showing hierarchy of the NCC and its compliance options is provided in Figure A.1. It should be read in conjunction with the NCC.

To access the NCC or for further general information regarding demonstrating compliance with the NCC visit the ABCB website (abcb.gov.au).

Figure A.1 Demonstrating compliance with the NCC

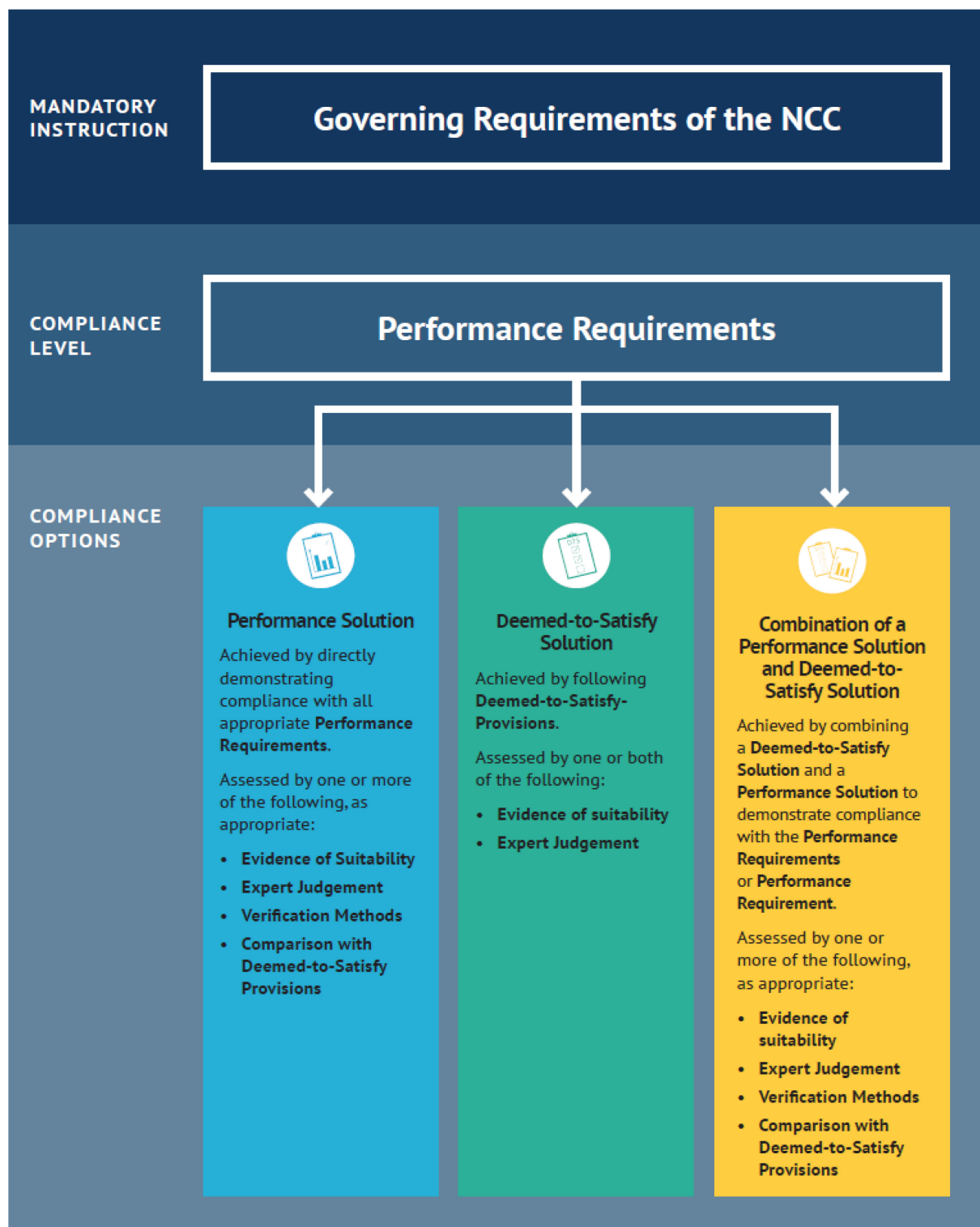

Appendix B Acronyms and symbols

The following table contains abbreviations and symbols used in this document.

Table B.1 General acronyms

Acronym/Symbol	Meaning
ABCB	Australian Building Codes Board
AFAC	Australasian fire and emergency service authorities council
AUBRCC	Australian Uniform Building Regulations Coordinating Council
AS	Australian Standard
ASET	Available Safe Egress Time
BCA	Building Code of Australia
BE	Fire blocks evacuation route
CF	Challenging fire
CFD	Computational Fluid Dynamics
CO	Carbon monoxide
COAG	Council of Australian Governments
CS	Fire starts in a concealed space
DTS	Deemed-to-Satisfy
FB	Fire Brigade
FBIM	Fire Brigade Intervention Model
FEB	Fire Engineering Brief
FED	Fractional Effective Dose
FI	Fire brigade intervention
FMEA	Failure mode and effects analysis
FO	Fire Origin
FRL	Fire Resistance Level
FSE	Fire safety engineer
FSVM	Fire Safety Verification Method

Acronym/Symbol	Meaning
HAZID	Hazard Identification
HAZOP	Hazard and operational study
HCN	Hydrogen Cyanide
HRR	Heat Release Rate
HS	Horizontal fire spread
IFEG	International Fire Engineering Guidelines
IGA	Inter-government agreement
IS	Fire spread involving internal finishes
ISCUBR	Interstate Standing Committee on Uniform Building Regulations
NCC	National Construction Code
NER	National Engineers Register
NFER	National Fire Engineers Register
NFPA	National Fire Protection Association
PBDB	Performance-Based Design Brief
PBDR	Performance-Based Design Report
PPE	Personal Protective Equipment
QRA	Quantitative Risk Analysis
RC	Robustness check
RSET	Required Safe Egress Time
SF	Smouldering fire
SOU	Sole-occupancy unit
SS	Structural stability
UF	Unexpected catastrophic failure
UT	Fire in a normally unoccupied room threatens occupants of other rooms
VS	Vertical fire spread involving cladding or arrangements of openings in walls.
WHS	Workplace Health and Safety

Table B.2 Design scenario acronyms

Ref	Design Scenario	Design scenario Description
BE	Blocked Evacuation Route	A fire blocks an <i>evacuation route</i>
UT	Unoccupied Threat	A fire starts in a normally unoccupied room and can potentially endanger occupants in another room
CS	Concealed Space	A fire starts in a concealed space that can facilitate fire spread and potentially endanger a large number of people in a room.
SF	Smouldering fire	A fire is smouldering in close proximity to a sleeping area
IS	Internal Spread	Fire spread involving internal surfaces exposed to a growing fire that potentially endangers occupants
CF	Challenging fire	Worst credible fire
RC	Robustness check	Failure of a critical part of the fire safety systems will not result in the design not meeting the Objectives of the NCC
SS	Structural Stability	Building does not present risk to other properties in a fire event
HS	Horizontal fire spread	<i>A fully developed fire</i> in a building exposes the external walls of a neighbouring building
VS	Vertical fire spread	Vertical fire spread involving cladding or arrangement of openings in walls. A fire source exposes a wall and leads to significant vertical fire spread
FI	Fire brigade intervention	Facilitate fire brigade intervention
UF	Unexpected Catastrophic Failure	A building must not unexpectedly collapse during a fire event

Appendix C Defined terms

Where the following terms are *italicised* in this document, the definitions below apply:

Appropriate authority as defined in the NCC means the relevant authority with the statutory responsibility to determine the particular matter.

[To provide clarity of terminology for the specific application of the appropriate authority determining compliance with the *Performance Requirements*, the definition of appropriate authority is expanded to mean the relevant authority with the statutory responsibility to determine the matter satisfies the relevant *Performance Requirements*.

Note 1: This is typically the building surveyor charged with the statutory responsibility to determine building compliance and issue the building permit / approval and occupancy certificate / approval.

Note 2: Some jurisdictions refer to building surveyors performing these functions as a building certifier].

Appropriately qualified person means a person recognised by the appropriate authority as having qualifications and/or experience in the relevant discipline in question.

Assessment Method means a method that can be used for determining that a *Performance Solution* or Deemed-to-Satisfy Solution complies with the *Performance Requirements*

Available safe egress time (ASET) means the time between ignition of a fire and the onset of untenable conditions in a specific part of a building. This is the calculated time interval between the time of ignition of a fire and the time at which conditions become such that the occupant is unable to take effective action to escape to a place of safety.

Burnout means exposure to fire for a time that includes fire growth, full development, and decay in the absence of intervention or automatic suppression, beyond which the

fire is no longer a threat to building elements intended to perform loadbearing or fire separation functions, or both.

Building solution means a solution which complies with the NCC *Performance Requirements* and is a—

- (a) Performance Solution; or
- (b) Deemed-to-Satisfy Solution; or
- (c) combination of (a) and (b).

Computational fluid dynamics (CFD) means an approach that uses applied mathematics, physics and computational software based on the Navier-Stokes equations to predict gas or fluid flow in a domain.

Design fire means the quantitative description of a representation of a fire within the design scenario.

Design scenario (reference design scenario) means the specific scenario of which the sequence of events can be quantified, and a fire safety engineering analysis conducted against. The term design fire scenario is commonly used in lieu of design scenario in many fire safety engineering texts and standards.

Detection time means the time interval between ignition of a fire and its detection by an automatic or manual system.

Fire means the process of combustion.

Fire decay means the stage of fire development after a fire has reached its maximum intensity and during which the heat release rate and the temperature of the fire are generally decreasing.

Fire growth means the stage of fire development during which the heat release rate and the temperature of the fire are generally increasing.

Fire safety engineer (or Fire Engineer or FSE) means a *professional engineer* with appropriate experience and competence in the field of fire safety engineering

Fire safety engineering means application of engineering principles, rules and expert judgement based on a scientific appreciation of the fire phenomenon, often

using specific *design scenarios*, of the effects of fire and of the reaction and behaviour of people in order to:

- save life, protect property and preserve the environment and heritage from destructive fire;
- quantify the hazards and risk of fire and its effects;
- mitigate fire damage by proper design, construction, arrangement and use of buildings, materials, structures, industrial processes and transportation systems;
- evaluate analytically the optimum protective and preventive measures, including design, installation and maintenance of active and passive fire and life safety systems, necessary to limit, within prescribed levels, the consequences of fire.

Fire safety level is a general term which can be considered the reciprocal of the fire risk such that if the risk to occupants from fire is reduced the fire safety level is increased.

Fire safety strategy means a combination of physical fire safety measures and human measures / factors including maintenance and management in use requirements which have been specified to achieve the nominated fire safety objectives.

Fractional effective dose (FED) means the fraction of the dose (of thermal effects) that would render a person of average susceptibility incapable of escape.

Comment:

The definition for FED has been modified from the ISO definition to be made specific for this Verification Method. The ISO definition is “Ratio of the exposure dose for an insult to that exposure dose of the insult expected to produce a specified effect on an exposed subject of average susceptibility.” The use of CO or CO₂ as part of FED is not part of this Verification Method. This is because our ability to measure CO in a repeatable test varies by two orders of magnitude for common cellulosic fuel. However, their use may be acceptable as part of a *Performance Solution* conducted outside the scope of this Verification Method.

Fully developed fire means the state of total involvement of the majority of combustible materials in a fire.

Heat of combustion means the thermal energy produced by combustion of unit mass of a given substance (kJ/kg).

Heat release means the thermal energy produced by combustion (kJ).

Heat release rate (HRR) means the rate of thermal energy production generated by combustion (kW (preferred) or MW).

Individual risk is the frequency at which an individual may be expected to sustain a given level of harm from the realisation of a specified hazard. In the context of this handbook individual risk is generally interpreted as the frequency at which an individual may be expected to be exposed to untenable conditions as a result of a fire in the subject building.

Optical density of smoke means the measure of the attenuation of a light beam passing through smoke expressed as the logarithm to the base 10 of the opacity of smoke.

Performance-Based Design Brief (PBDB) means a process and the associated report that defines the scope of work for the fire safety engineering analysis and the technical basis for analysis as agreed by stakeholders.

Note: The term Fire Engineering Brief (FEB) is used in the IFEG 2005 and other related guidance material for the equivalent of a PBDB. The PBDB is a general term relating to all disciplines.

Performance Requirement means a requirement which states the level of performance which a *Performance Solution* or Deemed-to-Satisfy Solution must meet.

Performance Solution means a design demonstrated as complying with the *Performance Requirements* other than by a Deemed-to-Satisfy Solution.

[the term *Performance Solution* refers to the entire building including management procedures that are required to ensure the fire safety strategy satisfies all the

relevant NCC performance requirements throughout the life of the building and must address all variations from the Reference DTS compliant Building)

Pre-travel activity time means the time period after an alarm or fire cue is transmitted and before occupants first begin to travel towards an exit.

Professional engineer means a person who is—

- (a) if legislation is applicable — a registered professional engineer in the relevant discipline who has appropriate experience and competence in the relevant field; or
- (b) if legislation is not applicable—
 - (i) registered in the relevant discipline on the National Engineering Register (NER) of the Institution of Engineers, Australia (which trades as ‘Engineers Australia’); or
 - (ii) eligible to become registered on the Institution of Engineers, Australia’s NER, and has appropriate experience and competence in the relevant field.

[Note: To provide clarity of terminology in relation to the application of the definition of a professional engineer in the discipline of Fire Safety Engineering in the context of this FSVM; the Institution of Engineers, Australia National Engineering Register (NER) has a Special Area of Practice for Fire Safety Engineering which is applicable to professional engineers in the discipline of fire safety engineering.]

Reference building, for the purposes of NCC Volume One, means, depending on the application, a hypothetical building that is used to calculate the maximum allowable annual energy load, or maximum allowable annual greenhouse gas emissions and determine the thermal comfort level annual energy consumption for the proposed building.

[or in the context of the FSVM, a hypothetical building that complies with the fire safety Deemed-to-Satisfy building and is used as a benchmark for the assessment of a *Performance Solution* using the *Fire Safety Verification Method*]

Reference design scenario means a specific scenario representing a cluster of scenarios of which the sequence of events can be quantified, and a fire safety engineering analysis conducted against. The reference design scenario is normally derived from a *Design Scenario* specified in the FSVM.

Required safe egress time (RSET) means the time required for escape. This is the time required for safe evacuation of occupants to a place of safety prior to the onset of untenable conditions.

Response time index (RTI) means the measure of the reaction time to a fire phenomenon of the heat responsive element of a fire safety system.

Separating element means a barrier that exhibits fire integrity, structural adequacy, insulation, or a combination of these for a period of time under specified conditions (often in accordance with AS 1530.4).

Societal risk is the relationship between frequency and the number of people suffering from a specified level of harm in a given population from the realisation of specified hazards. In the context of this handbook the “given population” is generally the population of the subject building (and adjacent buildings where appropriate) unless otherwise noted and the specified hazard is a fire within or involving the subject building (and adjacent buildings where appropriate).

Sole-occupancy unit (or SOU) means a room or other part of a building for occupation by one or joint owner, lessee, tenant, or other occupier to the exclusion of any other owner, lessee, tenant, or other occupier and includes—

- (a) a dwelling; or
- (b) a room or suite of rooms in a Class 3 building which includes sleeping facilities; or
- (c) a room or suite of associated rooms in a Class 5, 6, 7, 8 or 9 building; or
- (d) a room or suite of associated rooms in a Class 9c building, which includes sleeping facilities and any area for the exclusive use of a resident.

Travel distance means the distance that is necessary for a person to travel from any point within a building to another point, taking into account the layout of walls, partitions and fittings.

Verification Method means a test, inspection, calculation or other method that determines whether a *Performance Solution* complies with the relevant *Performance Requirements*.

Visibility means the maximum distance at which an object of defined size, brightness and contrast can be seen and recognised.

Worst credible fire in the context of the FSVM means the design fire that is expected to yield the most severe consequences of all identified design fires (relating to a prescribed *Design Scenario* under consideration) that can reasonably be expected to occur.

Yield means the mass of a combustion product generated during combustion divided by the mass loss of the test specimen as specified in the design fire.

Appendix D History of the NCC

D.1 Australian building regulatory system

The Australian Constitution sets out the roles, responsibilities and powers of the Australian Government. By standard convention, those matters that are not mentioned in the Constitution remain the responsibility of the States. As the Constitution does not mention matters regarding the safety, health and amenity of people in buildings, responsibility for them rests with the State and Territory Governments. This has led to eight separate Acts of Parliament and eight distinct building regulatory systems. At various times, it has been even more complex, with some states passing on many of their building regulatory powers to their municipal councils, which effectively enacted their own building regulatory systems by way of council by-laws.

D.2 Australia's Model Uniform Building Code

The complexity of Australia's building regulatory system provided a legislative maze for building practitioners to work through. However, after World War II several of the States and Territories started to establish more uniform technical building requirements, and those States and Territories which delegated their primary responsibilities to municipal councils started to reclaim control. This prompted further discussion about the benefits of having a national set of building regulations.

In 1965, the Interstate Standing Committee on Uniform Building Regulations (ISCUBR) was established. ISCUBR was an agreement between the State and Territory administrations responsible for building regulatory matters to pool their resources for the benefit of all States and Territories. ISCUBR's first task was to draft a model technical code for building regulatory purposes. The document was referred to as the "Australian Model Uniform Building Code" (AMUBC), and was first released in the early 1970's.

The AMUBC contained proposals for both technical matters and some administrative matters, which were based on the then Local Government Act of New South Wales.

The intention was that States and Territories could use the AMUBC as a model for their own building regulations. However, variation from the model was considerable, with many changing the provisions in accordance with their perceptions of local needs.

D.3 Building Code of Australia

In 1980, the Local Government Ministerial Council agreed to the formation of the Australian Building Regulations Coordinating Council (AUBRCC) to supersede ISCUBR. AUBRCC's main task was to continue to develop the AMUBC, which led to the production of the first edition of the BCA in 1988^[45].

The BCA 1988 sought to establish a uniform set of technical requirements and standards for the design and construction of buildings and other structures throughout Australia.

It was broadly based on the consolidation and rationalisation of earlier prescriptive technical provisions previously contained in State and Territory legislation which had evolved over time in response to, amongst other things, loss of life, and tended to mirror community values and risk appetite in terms of individual and societal risk associated with specific hazards. During the preparation of the BCA 1988 there was an opportunity to consider whether historic provisions could be improved.

The BCA was further refined, and a new edition was released in 1990^[46] which also included Appendices identifying variations to the BCA provisions that applied within a specific State or Territory.

In 1991, the Building Regulation Review Task Force recommended to COAG the establishment of a body to achieve far-reaching national reform. An IGA was signed in April 1994 to establish the ABCB. One of the first tasks of the ABCB was to convert the BCA into a more fully performance-based document.

The ABCB released the performance-based BCA (BCA96)^[9] in October 1996. BCA96 was adopted by the Commonwealth and most states and territories on 1 July 1997, with the remainder adopting it by early 1998.

Between 1996 and 2003 there were 13 amendments to the BCA96 which included technical changes that;

- reflected developments in the field of fire safety engineering including incorporation of some findings from the Fire Code Reform Centre and preceding Warren Centre.
- inclusion of content to address contemporary issues
- reductions in the content of State and Territory Appendices by removal of unnecessary variations
- referencing updated technical standards

In 2003 a decision was taken to move to an annual amendment cycle with a date of operation from 1 May each year. From 2004, the BCA moved from BCA96 to become BCA 2004^[47], BCA 2005 in 2005 and so on. These regular amendments facilitated continued improvement of the Code and in many cases, changes to fire related provisions reflecting developments in the field of fire safety engineering.

D.4 Transition to the NCC

In 2011 the BCA was incorporated into the NCC, which was amended annually until 2016 when a 3-year amendment cycle was introduced.